

User Manual

MDL4U and MDL4UB Series Modular Programmable DC Electronic Loads



Contents

1	Compliance Information	5
1.1	EMC	5
1.2	IEC Measurement Category & Pollution Degree Definitions	6
1.3	Product End-of-Life Handling	7
1.4	Terms and Symbols	7
2	Safety Notices	9
3	Introduction	15
3.1	Product Overview	15
3.2	Features	17
3.3	Dimensions	17
3.4	Front Panel	18
3.5	Rear Panel	20
3.6	Protection Functions	22
3.6.1	Overvoltage Protection (OVP)	22
3.6.2	Operations to Clear the OVP State	22
3.6.3	Overcurrent Protection (OCP)	23
3.6.4	Overpower Protection (OPP)	24
3.6.5	Overtemperature Protection (OTP)	25
3.6.6	Reverse Voltage Protection (LRV/RRV)	25
3.7	Menu List	26
4	Installation	31
4.1	Inspection	31
4.2	Cleaning	31
4.3	Installing Modules	32
4.4	Channel Number	34
4.5	Location	35
4.6	Input Voltage Selection	36
4.7	Turn-On Checkout	37
4.8	If the Electronic Load Does Not Turn On.	37
5	Load Connection	39
5.1	Parallel Connection	41
5.2	Mainframe 8-pin Control Connector	42
5.3	External Trigger Connections	43
5.3.1	Trigger Modes	43
5.4	External ON/OFF Control Connection	44
5.5	Mainframe Extension Connection	45

5.6	PC Control Connection	46
6	Operations	47
6.1	Operation Modes	47
6.1.1	Constant Current (CC) Mode	47
6.1.2	Constant Voltage (CV) Mode	50
6.1.3	Constant Resistance (CR) Mode	52
6.1.4	Constant Power (CP) Mode	54
6.1.4.1	Setting CV,CC,CR, CW Mode	56
6.2	Local Operations	57
6.2.1	Mainframe Panel	57
6.2.2	Module Panel	60
6.2.3	Module Panel Lock	61
6.3	Switching Channels	62
6.4	Channel Synchronization	62
6.5	Module VFD Indicator Function Description	63
6.6	Transient Operation	64
6.6.1	Continuous	64
6.6.2	Pulse	65
6.6.3	Toggle	66
6.6.4	Setting Up A/B Transient Operation	66
6.7	List Operation	68
6.7.1	Setting Up List Operation Mode	69
6.8	Trigger Operation	71
6.8.1	Manual Trigger	71
6.8.2	External Trigger Signal(TTL level)	71
6.8.3	Hold Trigger	71
6.8.4	Bust Trigger	71
6.8.5	Timer Trigger	71
6.9	Short Operation	72
6.10	Input On/Off Operation	72
6.11	Von Operation	72
6.12	Save and Recall Operation	75
6.13	Module Controlling Link	76
6.13.1	Voltage Failure Indication	76
6.13.2	Current Monitoring	76
6.13.3	Digital I/O	77
6.13.4	Remote Sense Function	77
6.13.5	External Analog Control	77
6.14	Automatic Test	77
6.15	Configuring Pass/Fail Paramters	77
6.15.1	Configuring Instrument Settings	78
6.15.2	Recall Test Files	81

6.16 Remote Operation	83
6.16.1 USB Interface	84
6.16.2 Ethernet Interface	84
6.16.3 GPIB Interface	84
7 Specifications	88
8 Service Information	93
9 LIMITED THREE-YEAR WARRANTY	94

Compliance Information

1.1 EMC

EC Declaration of Conformity - EMC

Compliance was demonstrated to the following specifications listed in the Official Journal of the European Communities: EMC Directive 2014/30/EU.

EN 61010-1:2010 Safety requirements for electrical equipment for measurement, control, and laboratory use Part 1: General requirements

1.2 IEC Measurement Category & Pollution Degree Definitions

Measurement Category (CAT) - classification of testing and measuring circuits according to the types of mains circuits to which they are intended to be connected.

Measurement Category other than II, III, or IV : circuits that are not directly connected to the mains supply.

Measurement Category II (CAT II) : test and measuring circuits connected directly to utilization points (socket outlets and similar prints) of the low-voltage mains installation.

Measurement Category III (CAT III) : test and measuring circuits connected to the distribution part of a building's low-voltage mains installation.

Measurement Category IV (CAT IV) : test and measuring circuits connected at the source of the building's low-voltage mains installation.

Mains Isolated : is for measurements performed on circuits not directly connected to a mains supply.

Pollution - addition of foreign matter, solid, liquid, or gaseous (ionized gases) that may produce a reduction of dielectric strength or surface resistivity.

Pollution Degree 2 (P2) - only non-conductive pollution occurs except that occasionally a temporary conductivity caused by condensation is expected

1.3 Product End-of-Life Handling

The equipment may contain substances that could be harmful to the environment or human health if improperly handled at the product's end of life. To avoid release of such substances into the environment and to reduce the use of natural resources, we encourage you to recycle this product to an appropriate system that will ensure that most of the materials are reused or recycled appropriately.



This product is subject to Directive 2012/19/EU of the European Parliament and the Council of the European Union on waste electrical and electronic equipment (WEEE), and in jurisdictions adopting that Directive, is marked as being put on the market after August 13, 2005, and should not be disposed of as unsorted municipal waste. Please utilize your local WEEE collection facilities in the disposition of this product.

1.4 Terms and Symbols

Terms

CAUTION

A caution statement calls attention to an operating procedure, practice, or condition, which, if not followed correctly, could result in damage to or destruction of parts or the entire product.

WARNING

A warning statement calls attention to an operating procedure, practice, or condition, which, if not followed correctly, could result in injury or death to personnel.

NOTICE

A note statement calls attention to an operating procedure, practice, or condition, which, should be noted before proceeding.

Symbols



WARNING - HIGH VOLTAGE - possibility of electric shock.



CAUTION – Statements or instructions that must be consulted in order to find out the nature of the potential hazard and any actions which must be taken.



On (Supply). This is the AC mains connect/disconnect switch on the front of the instrument.

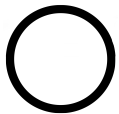

Off (Supply). This is the AC mains connect/disconnect switch on the front of the instrument.



Alternating current



Chassis (earth ground) symbol



Earth (ground) TERMINAL - Refer to the instructions accompanying this symbol in this manual.

Safety Notices

The following safety precautions apply to both operating and maintenance personnel and must be followed during all phases of operation, service, and repair of this instrument.

Before applying power to this instrument:

- Read and understand the safety and operational information in this manual.
- Apply all the listed safety precautions.
- Verify that the voltage selector at the line power cord input is set to the correct line voltage. Operating the instrument at an incorrect line voltage will void the warranty.
- Make all connections to the instrument before applying power.
- Do not operate the instrument in ways not specified by this manual or by B&K Precision.

Failure to comply with these precautions or with warnings elsewhere in this manual violates the safety standards of design, manufacture, and intended use of the instrument. B&K Precision assumes no liability for a customer's failure to comply with these requirements.

Electrical Power

This instrument is intended to be powered from a CATEGORY II mains power environment. The mains power should be 115 V RMS or 230 V RMS. Use only the power cord supplied with the instrument and ensure it is appropriate for your country of use.



Do not use this instrument in an electrical environment with a higher category rating than what is specified in this manual for this instrument.



You must ensure that each accessory you use with this instrument has a category rating equal to or higher than the instrument's category rating to maintain the instrument's category rating. Failure to do so will lower the category rating of the measuring system.

Ground the Instrument

! WARNING

To minimize shock hazard, the instrument chassis and cabinet must be connected to an electrical safety ground. This instrument is grounded through the ground conductor of the supplied, three-conductor AC line power cable. The power cable must be plugged into an approved three-conductor electrical outlet. The power jack and mating plug of the power cable meet IEC safety standards.

! WARNING

Do not alter or defeat the ground connection. Without the safety ground connection, all accessible conductive parts (including control knobs) may provide an electric shock. Failure to use a properly-grounded approved outlet and the recommended three-conductor AC line power cable may result in injury or death.

! WARNING

Unless otherwise stated, a ground connection on the instrument's front or rear panel is for a reference of potential only and is not to be used as a safety ground. Do not operate in an explosive or flammable atmosphere.

Environmental Conditions

This instrument is intended to be used in an indoor pollution degree 2 environment. The operating temperature range is 0°C to 40°C and 20% to 80% relative humidity, with no condensation allowed.

Measurements made by this instrument may be outside specifications if the instrument is used in non-office-type environments. Such environments may include rapid temperature or humidity changes, sunlight, vibration and/or mechanical shocks, acoustic noise, electrical noise, strong electric fields, or strong magnetic fields.



Do not operate the instrument in the presence of flammable gases or vapors, fumes, or finely-divided particulates.

The instrument is designed to be used in office-type indoor environments. Do not operate the instrument

- **In the presence of noxious, corrosive, or flammable fumes, gases, vapors, chemicals, or finely-divided particulates.**
 - **In relative humidity conditions outside the instrument's specifications.**
 - **In environments where there is a danger of any liquid being spilled on the instrument or where any liquid can condense on the instrument.**
 - **In air temperatures exceeding the specified operating temperatures.**
 - **In atmospheric pressures outside the specified altitude limits or where the surrounding gas is not air.**
 - **In environments with restricted cooling air flow, even if the air temperatures are within specifications.**
 - **In direct sunlight.**
-



Do not operate instrument if damaged

! WARNING

If the instrument is damaged, appears to be damaged, or if any liquid, chemical, or other material gets on or inside the instrument, remove the instrument's power cord, remove the instrument from service, label it as not to be operated, and return the instrument to B&K Precision for repair. Notify B&K Precision of the nature of any contamination of the instrument.

! WARNING

Hazardous voltages may be present in unexpected locations in circuitry being tested when a fault condition in the circuit exists.

Clean the instrument only as instructed

! WARNING

Do not clean the instrument, its switches, or its terminals with contact cleaners, abrasives, lubricants, solvents, acids/bases, or other such chemicals. Clean the instrument only with a clean dry lint-free cloth or as instructed in this manual. Not for critical applications.

Do not touch live circuits

⚠ WARNING

Instrument covers must not be removed by operating personnel. Component replacement and internal adjustments must be made by qualified service-trained maintenance personnel who are aware of the hazards involved when the instrument's covers and shields are removed. Under certain conditions, even with the power cord removed, dangerous voltages may exist when the covers are removed.

To avoid injuries, always disconnect the power cord from the instrument, disconnect all other connections (for example, test leads, computer interface cables, etc.), discharge all circuits, and verify there are no hazardous voltages present on any conductors by measurements with a properly-operating voltage-sensing device before touching any internal parts. Verify the voltage-sensing device is working properly before and after making the measurements by testing with known-operating voltage sources and test for both DC and AC voltages.

Do not attempt any service or adjustment unless another person capable of rendering first aid and resuscitation is present.

General Safety

⚠ WARNING

Do not insert any object into an instrument's ventilation openings or other openings.

⚠ WARNING

This instrument is not authorized for use in contact with the human body or for use as a component in a life-support device or system.

Servicing

! WARNING

Do not substitute parts that are not approved by B&K Precision or modify this instrument. Return the instrument to B&K Precision for service and repair to ensure that safety and performance features are maintained.

! WARNING

Fuse replacement must be done by qualified service-trained maintenance personnel who are aware of the instrument's fuse requirements and safe replacement procedures. Disconnect the instrument from the power line before replacing fuses. Replace fuses only with new fuses of the fuse types, voltage ratings, and current ratings specified in this manual or on the back of the instrument. Failure to do so may damage the instrument, lead to a safety hazard, or cause a fire. Failure to use the specified fuses will void the warranty.

For continued safe use of the instrument

- Do not place heavy objects on the instrument.
- Do not obstruct cooling air flow to the instrument.
- Do not place a hot soldering iron on the instrument.
- Do not pull the instrument with the power cord, connected probe, or connected test lead.
- Do not move the instrument when a probe is connected to a circuit being tested.

Introduction

3.1 Product Overview

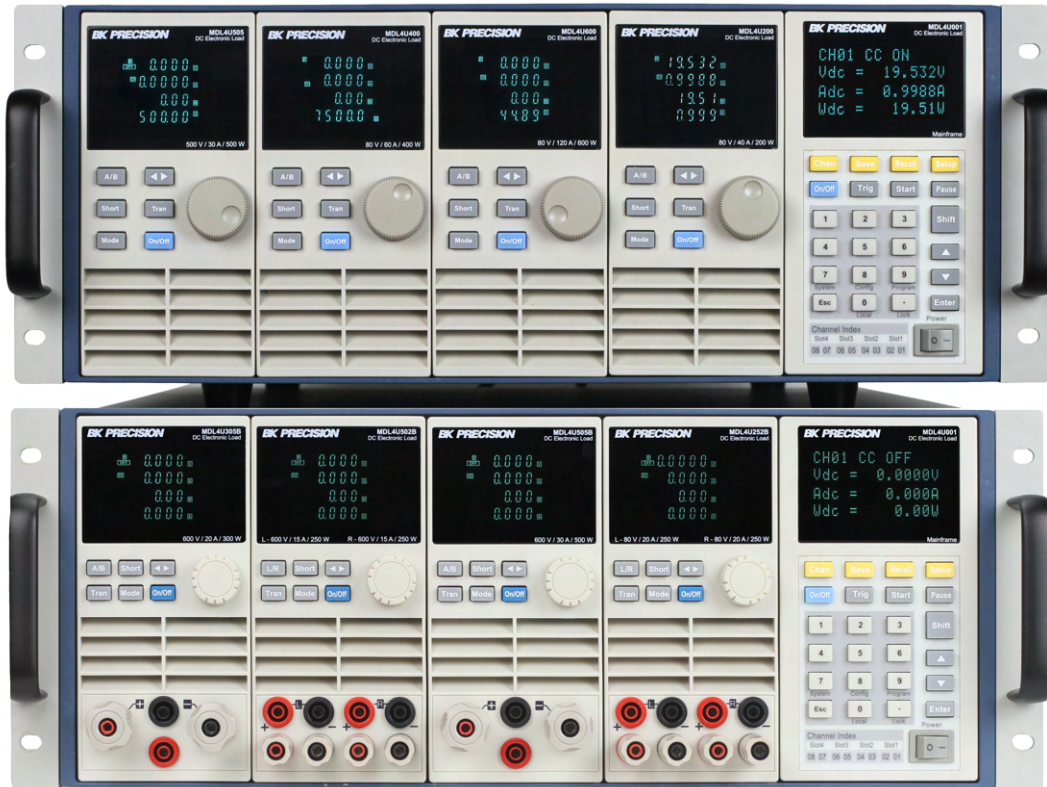

Figure 3.1 MDL4U/MDL4UB Series

The MDL4U/MDL4B Series is a multi-channel modular programmable electronic load system, offering seven(MDL4U)/nine(MDL4UB) module options with power capacities ranging from 150 W to 600 W to test various power sources, including multi-output DC power supplies, batteries, fuel cells, and photovoltaic arrays. The mainframe features a controller and four slots that accommodate any module combination up to 2400 W, expandable to 4800 W with a mainframe extension. The range of each module's specific voltage, current, and power is listed in the Specifications section.

Operating in constant current (CC), constant voltage (CV), constant resistance (CR), and constant power (CW) modes, the MDL4UB Series allows users to edit parameters such as voltage, current, slew rate, and width via the front panel. Test parameters can be saved in any of 101 memory areas for efficient recall. For remote operation, the series includes LAN, USB (USBTMC-compliant), RS232, and GPIB interfaces with SCPI command protocol support.

Model	MDL4U200	MDL4U252	MDL4U302	MDL4U305	MDL4U400	MDL4U505	MDL4U600
Power	200 W	*250 W / 50 W	*300 W / 300 W	300 W	400 W	500 W	500 W
Operating Voltage	80 V	80 V	80 V	500 V	80 V	500 V	80 V
Rated Current	40 A	20 A	45 A	20 A	60 A	30 A	120 A
No. of Channels	1	2	2	1	1	1	1

Table 3.1 MDL4U Modules

* The MDL4U252 and MDL4U302 are dual-channel load modules. The MDL4U252 can allocate up to 250 W to either channel up to 300 W total. (e.g. 250 W/50 W, 150 W/150 W). Similarly, the MDL4U302 can allocate 300 W to either channel up to 600 W total (e.g. 300 W/300 W)

NOTICE

Model	MDL4U102B	MDL4U200B	MDL4U252B	MDL4U302B	MDL4U305B	MDL4U400B	MDL4U502B	MDL4U505B	MDL4U600B
Power	*150 W / 150 W	200 W	*250 W / 50 W	*300 W / 300 W	300 W	400 W	*250 W / 250 W	500 W	500 W
Operating Voltage	80 V	80 V	80 V	80 V	500 V	80 V	600 V	600 V	80 V
Rated Current	20 A	40 A	20 A	45 A	20 A	60 A	15 A	30 A	120 A
No. of Channels	2	1	2	2	1	1	2	1	1

Table 3.2 MDL4UB Modules

*The MDL4U252B and MDL4U302B are dual-channel load modules. The MDL4U252B can allocate up to 250 W to either channel up to 300 W total. (e.g. 250 W/50 W, 150 W/150 W). Similarly, the MDL4U302B can allocate 300 W to either channel up to 600 W total (e.g. 300 W/300 W). In addition the MDL4U102B can allocate 150 W to either channel up to 300 W total, and the MDL4U502B can allocate 250 W to either channel up to 500 W total.

NOTICE

3.2 Features

- Power range: up to 2400 W
- Voltage range: up to 600 V
- Current range: up to 120 A
- Operating modes: CC, CV, CR, CW
- Removable modules for system configurability
- Supports up to 16 channels with dual-channel modules
- Parallel mode operation for high current applications
- Synchronous load on/off function
- Interfaces: LAN, GPIB, USB, RS232 (USBTMC/SCPI protocol)
- Analog current control and monitoring
- Transient mode: up to 25 kHz
- List mode: 20 μ s step width, 84 programmable steps
- Adjustable slew rate in CC mode
- High measurement: 16-bit, 0.1 mV/0.01 mA
- Protection: OVP, OCP, OPP, OTP, reverse voltage
- Includes rack-mount brackets with handles

3.3 Dimensions

The MDL4U's and MDL4uB's dimensions are as follow:

Model	MDL4U001	MDL4U002	MDL4U102B, MDL4U302(B), MDL4U305(B), MDL4U400(B), MDL4U502(B), MDL4U505(B), MDL4U600(B)
Type	Mainframe	Mainframe Extension	Module
Dimensions (W x H x D)	17.3" x 7" x 21.6" (440 x 177.3 x 549 mm)	17.3" x 7" x 21.6" (440 x 177.3 x 549 mm)	3.2" x 6.7" x 22.6" (82 x 170.5 x 573 mm)
Weight	34 lbs (15.4 kg)	34 lbs (15.4 kg)	11 lbs (5 kg)

Table 3.3 Dimensions

3.4 Front Panel

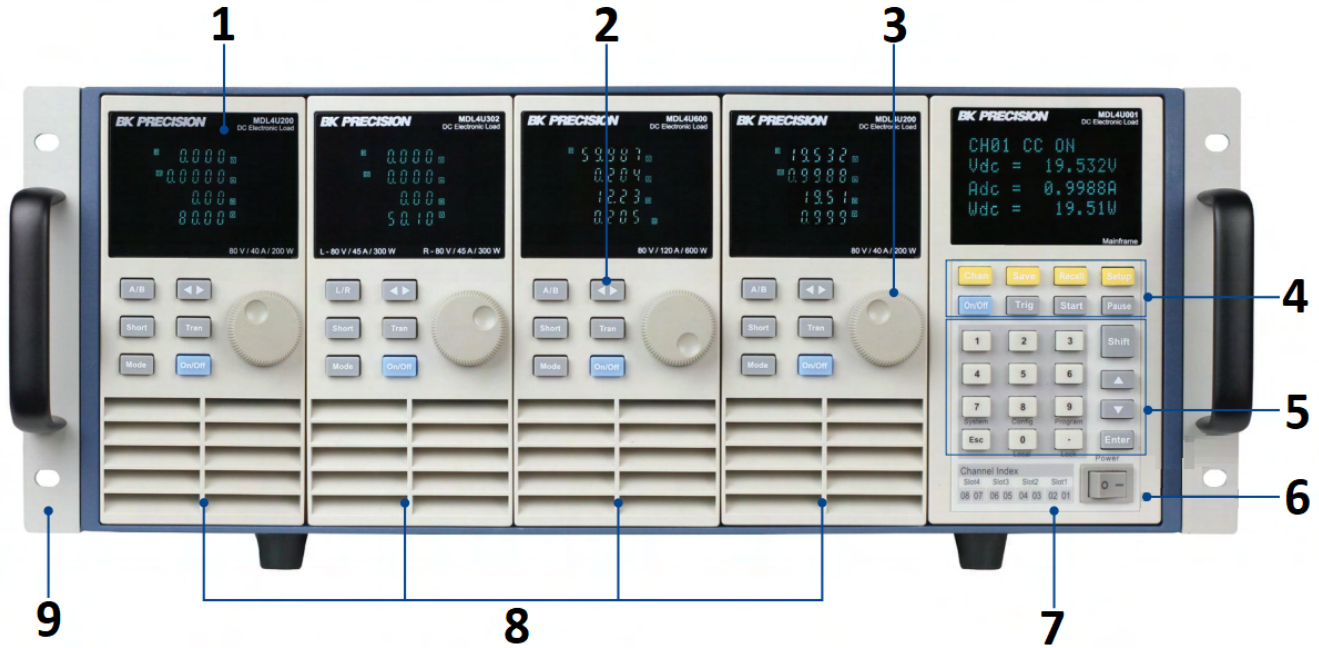

Figure 3.2 MDL4U Front Panel

Item	Name	Description
1	VFD Display	Displays electronic load information.
2	Module Panel Keys	Controls module functions. Refer to Module section for more details.
3	Rotary Knob	Used to change parameters.
4	Mainframe Function Keys	Controls each channel's operating status. Refer to Mainframe for more details.
5	Mainframe Numeric Keypad	Used to enter precise values when adjusting parameters.
6	Power Switch	Turns the system ON or OFF .
7	Mainframe Index	Channel index indicating the corresponding slot's channels.
8	Modules	Select and add any combination of 4 modules including dual-channel modules.
9	Rack-Mount Ear	Ears that protrude out on each side to be fastened to the frame with screws.

Table 3.4 Front Panel

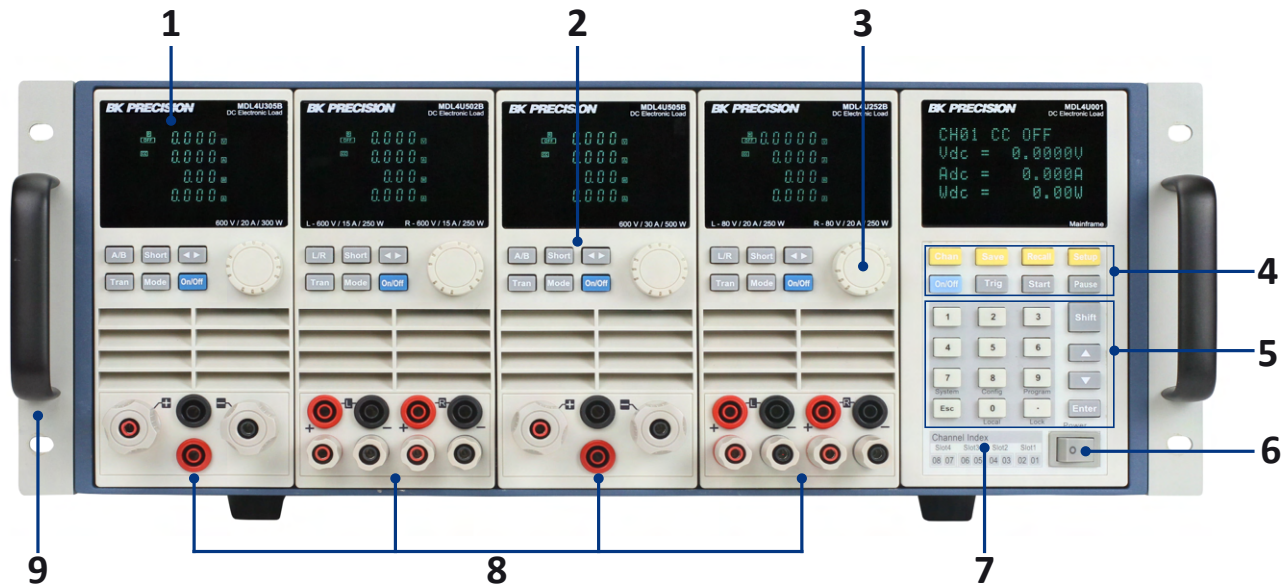

Figure 3.3 MDL4UB Front Panel

Item	Name	Description
1	VFD Display	Displays electronic load information.
2	Module Panel Keys	Controls module functions. Refer to Module section for more details.
3	Rotary Knob	Used to change parameters.
4	Mainframe Function Keys	Controls each channel's operating status. Refer to Mainframe for more details.
5	Mainframe Numeric Keypad	Used to enter precise values when adjusting parameters.
6	Power Switch	Turns the system ON or OFF .
7	Mainframe Index	Channel index indicating the corresponding slot's channels.
8	Module's Input	Front panel input terminals.
9	Rack-Mount Ear	Ears that protrude out on each side to be fastened to the frame with screws.

Table 3.5 Front Panel

3.5 Rear Panel

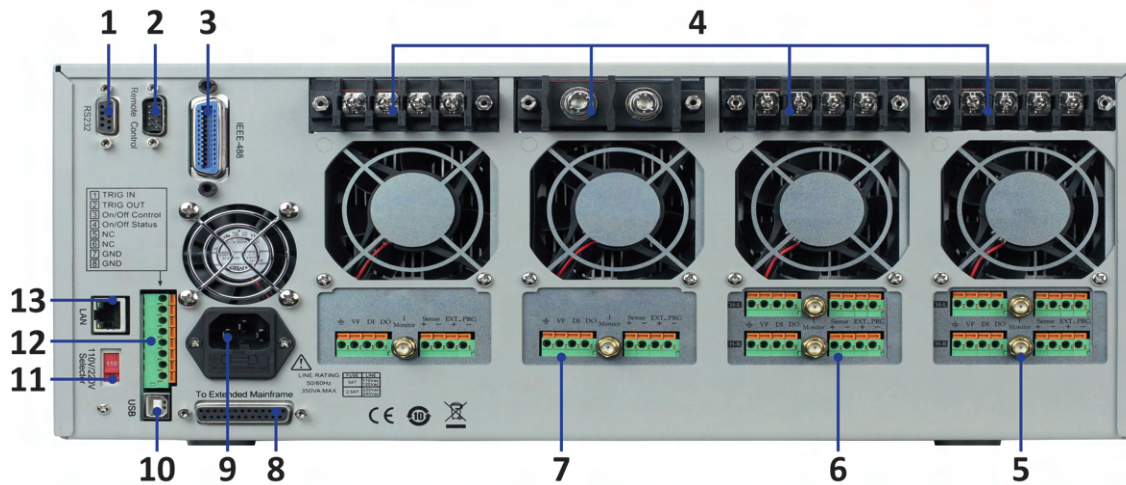

Figure 3.4 MDL4U Rear Panel

Item	Name	Description
1	RS232 Interface	Serial COM interface (DB9) used for remote of the unit.
2	Not Used	For factory use only.
3	GPIB Interface	GPIB interface used for remote control of the unit.
4	Module Input Terminal	Load input terminals.
5	Current Monitoring	Provides a proportional analog signal representing the real-time current drawn by the load.
6	Sense/External Control	Sense: Accurately measure the voltage directly at the load's connection point, compensating for any voltage drops that may occur. External Control: Accepts a proportional analog signal (0 - 10 V) to control the voltage or current configuration of the load.
7	Digital I/O and VF Output	Digital I/O: Universal output terminal use to control an external instrument. VF Output: Voltage fault indication terminal.
8	Extended Mainframe	Connects MDL4U001 to MDL4U002 to expand channel capacity.
9	Fused IEC Inlet	Houses the fuse and provides a secure connection of an AC power cord.
10	USB Interface	Connect a USB type B to type A to remotely control the unit.
11	Line Voltage Selection	Select 110/220V±10%AC input.
12	Sync Control	Refer to section 8-pin Control Connector for more details.
13	LAN Interface	Allows integration of the load into a local area network (LAN).

Table 3.6 MDL4U Rear Panel

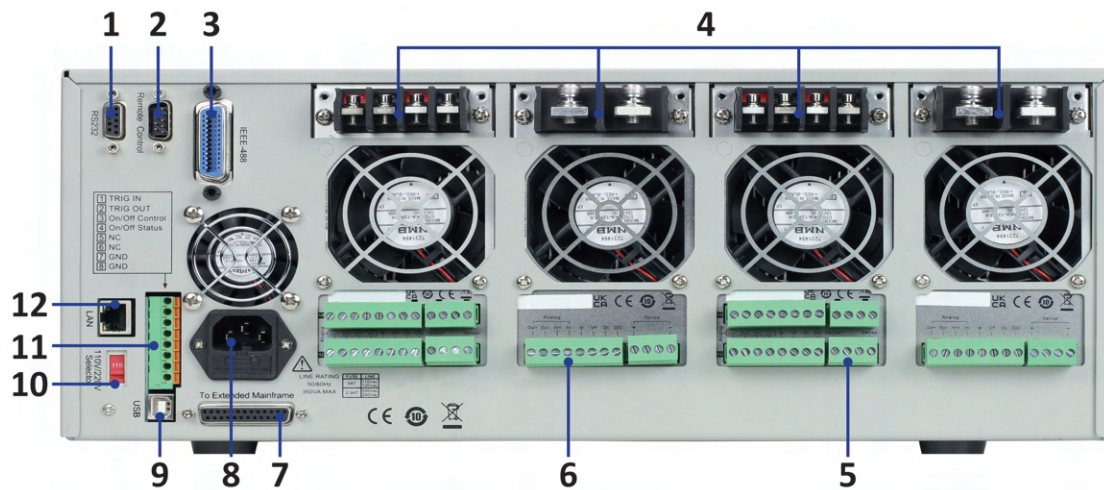

Figure 3.5 MDL4UB Rear Panel

Item	Name	Description
1	RS232 Interface	Serial COM interface (DB9) used for remote of the unit.
2	Not Used	For factory use only.
3	GPIB Interface	GPIB interface used for remote control of the unit.
4	Module Input Terminal	Load input terminals.
5	Sense/External Control	Sense: Accurately measure the voltage directly at the load's connection point, compensating for any voltage drops that may occur. External Control: Accepts a proportional analog signal (0 - 10 V)to control the voltage or current configuration of the load.
6	Digital I/O and VF Output	Digital I/O: Universal output terminal use to control an external instrument. VF Output: Voltage fault indication terminal.
7	Extended Mainframe	Connects MDL4U001 to MDL4U002 to expand channel capacity.
8	Fused IEC Inlet	Houses the fuse and provides a secure connection of an AC power cord.
9	USB Interface	Connect a USB type B to type A to remotely control the unit.
10	Line Voltage Selection	Select 110/220V±10%AC input.
11	Sync Control	Refer to section 8-pin Control Connector for more details.
12	LAN Interface	Allows integration of the load into a local area network (LAN).

Table 3.7 MDL4UB Rear Panel

3.6 Protection Functions

The electronic load has the following protection functions: Overvoltage protection (OVP), overcurrent protection (OCP), overpower protection (OPP), overtemperature protection (OTP), and local and remote reverse voltage protection (LRV/RRV).

The mainframe will act appropriately once any of the above protections are active. You can press any button on the front panel to restore the protection function. For example, if the electronic load triggers the overtemperature protection, the buzzer will alarm, the input will automatically turn off, and the mainframe VFD will display OTP.

3.6.1 Overvoltage Protection (OVP)

If the OVP circuit has triggered, input will turn off, buzzer alarm will go off, and the status register's OV and VF bit will be set. The mainframe will display OVP and the condition will remain until they are reset. Once overvoltage protection occurs, the 8-pin connector's VF pin on the rear panel will output TTL high voltage level. You can control the output state of the power supply under test via this pin (see Figure 6.15).

3.6.2 Operations to Clear the OVP State







Check whether the input voltage is within the electronic load's rated voltage or the programmed protection voltage ranges. If it is outside the range, please disconnect the device under test. Then press any key on the front panel or remotely send SCPI command PROtection:CLEar. The OVP displayed on the front panel will turn off and the electronic load exits OVP protection state.

3.6.3 Overcurrent Protection (OCP)

The electronic load includes both hardware and software overcurrent protection features.

Hardware OCP - The electronic load's maximum input current will be limited to approximately 110% of the current range. Once the hardware OCP is triggered, the status register's OC bit will be set. When the hardware OCP is removed, the status register's OC bit will be reset. Hardware overcurrent protection will not affect the electronic load's on/off state.

To set the electronic load's OCP value:

1. Power on the electronic load. Self-test
2. Press  +  to enter Configuration menu.
3. Press  key to select **PProtect** and press Enter to go into protection menu.
4. Press  key to select **Alimit State** and press Enter.
 - Select **On** and press Enter to confirm.
5. Press  key to select **Alimit Point** and press Enter.
 - Input OCP current value and press Enter to confirm.
6. Press  key to select **Alimit Delay** and press Enter.
 - Input delay time before alarm and press Enter to confirm.
7. Press Esc key to exit menus

If the electronic load's current value is above the set overcurrent protection value, the electronic load will automatically turn off and the VFD will display OCP. At the same time, the OC and PS bits in the status register will be set and remain until they are reset.

Operations To Clear the OCP State





Check whether the input current is within the electronic load's rated current or the programmed protection current ranges. If it is outside the range, disconnect the device under test. Then press any key on the front panel or remotely send SCPI command PROTECTION:CLEAR. The OCP displayed on the front panel will turn off and the load exits OCP protection state.

3.6.4 Overpower Protection (OPP)

The electronic load includes both hardware and software OPP features.

Hardware OPP – In the event that the electronic load's input power exceeds the set power protection limit, the hardware OPP will limit the power. Once the hardware OPP is triggered, the status register's OP bit will be set. When the hardware OPP is removed, the status register's OP bit will be reset. Hardware overpower protection will not turn the electronic load's input off.

To set the electronic load's OPP value:

1. Power on the electronic load. Self-test
2. Press  +  to enter Configuration menu.
3. Press  key to select **PProtect** and press Enter to go into protection menu.
4. Press  key to select **Plimit Point** and press Enter.
 - Input OPP power value and press Enter to confirm.
5. Press  key to select **Plimit Delay** and press Enter.
 - Input delay time before alarm and press Enter to confirm.
6. Press Esc key to exit menus

If the electronic load's power value is above the set overpower protection value, the electronic load will automatically turn off and the VFD will display OPP. At the same time, the OP and PS bits in the status register will be set and remain until they are reset.

Operations to Clear the OPP State

Check whether the input power is within the rated power range or the programmed protection ranges. If it is outside the range, disconnect the device under test. Then press any key on the front panel or remotely send command PROTection:CLEar. The OPP displayed on the front panel will turn off and the electronic load exits OPP protection state.

3.6.5 Overtemperature Protection (OTP)

Each module has an overtemperature protection circuit, which will turn off the input if the internal temperature exceeds safe limits. When the electronic load's internal circuit temperature is over 85°C, the load will enable OTP. Input will automatically be turned off and the VFD will display OTP. At the same time the OT and PS bits in the status register will be set and remain until they are reset.

Operations to Clear the OTP State

When the electronic load temperature has dropped below the protection point, press any key on the front panel or remotely send command PROTection:CLEAr. The OTP displayed on the front panel will turn off and the electronic load exits OTP protection state.

3.6.6 Reverse Voltage Protection (LRV/RRV)





This function protects the electronic load in case the input DC voltage lines are connected with the wrong polarity. When a reverse voltage (LRV – local reverse voltage, RRV – remote reverse voltage) connection condition is detected, the input will immediately turn off, the buzzer will alarm the user, and the status register's reverse voltage (LRV/RRV) and VF bits will be set. The mainframe will display LRV/RRV until they are reset.

In this condition, the 8-pin connector's VF pin will output a high level. You can disconnect the power supply via this signal (see Figure 6.15).

Operations to Clear the Reverse Voltage State

Check whether the connection is reversed. If so, disconnect the device to be measured to clear the reverse voltage state.

3.7 Menu List

The following menus can be viewed on the VFD display. Use the   keys to scroll through the menu list. Press the Enter key to enter the selected menu function. Use the   keys to scroll through the VFD screen and press Enter key to enter its submenu. Press Esc to go back to the previous menu selection. Pressing number keys can directly select a channel.

Press the the  key to enter the **Setup** menu.

Setup		
MODE	Select working mode	
	CONST CURRENT	Load works in CC mode
	CONST VOLTAGE	Load works in CV mode
	CONST RESISTANCE	Load works in CR mode
	CONST POWER	Load works in CW mode
CC/CV RANGE	Switch the range	
	HIGH RANGE	Set high range
	LOW RANGE	Set low range
I / V / R / W SET	Set the working current/voltage/resistance/power value	
Vmax/Amax	Set up the maximum voltage/current limit for Automatic test mode	
Vmin/Amin	Set up the minimum voltage/current limit for Automatic test mode	
$\int = 2.500A/us$	Set the rising slew rate (only in CC mode)	
$\int = 2.500A/us$	Set the falling slew rate (only in CC mode)	
TRAN A = 0.00A	Set up level A value	
Ta = 0.0005S	Set up level A width	
TRAN B = 0.00A	Set up level B value	
Tb = 0.0005S	Set up level B width	
T MODE	Set up the transient mode	
	CONTINUOUS	Continuous
	PULSE	Pulse mode
	TOGGLE	Toggle mode
RLC R = 7500.0Ω	Set up the resistance value	
EXIT	Exit the setup menu	

Table 3.8 Setup Menu

System Menu

Press  +  to enter the **System** menu.



MENU		
INITIALIZE		
	INITIALIZE DEFAULT SET	Resume all configuration to default settings
POWER ON SET		
	RST (DEFAULT)	Set the load's input state to default at power on
	SAV0	Set the load's input state to SAV0 at power on
BUZZER SET	Set up the buzzer state	
	ON	Enable the function
	OFF (DEFAULT)	Disable the function
LOAD ON KNOB	Module knob mode setting	
	UPDATE (DEF)	Real-time update
	OLD	No update (when turning load ON/OFF, original value before use of rotary knob will be set)
TRIGGER SOUR.	Set up the trigger mode	
	MANUAL (DEF)	Manual trigger
	EXTERNAL	External signal trigger mode
	HOLD	Hold trigger mode
	BUS	Bus trigger mode
	TIMER	Timer trigger
TRIGGER TIMER	Trigger timer setting	
	TRIGGER TIMER SET	Set the time of the trigger timer
COMMUNICATION	Select the interface for remote communication	
	RS232 (DEF)	
	USBTMC-USB488	
	GPIB	
	ETHERNET	

Table 3.9 System Menu

System Menu Cont...		
RS232 SET		
	BAUDRATE SET	Set up the communication baud rate
		4800 (DEFAULT)
		9600
		19200
		38400
		57600
		115200
	PARITY SET	Set up the communication parity
		NONE (DEFAULT)
		ODD
		EVEN
	HANDSHAKE SET	Select the handshake protocol
		NONE (DEFAULT)
		CTS/RTS
		XON/XOFF
GPIB ADDRESS	GPIB address setting	
	GPIB ADDRESS SET	Set up communication address
ETHERNET SET	Ethernet settings	
	GATEWAY SET	Gateway setting
	IP SET	IP setting
	MASK SET	Mask setting
	PORT SET	Port setting
	EXIT	
EXPAND MODULE	Module expansion	
	ON	Enable the function
	OFF (DEFAULT)	Disable the function
LANGUAGE SET	Communication protocol	
	SCPI (DEFAULT)	SCPI protocol
	EXTEND TABLE	Expand SCPI protocol, compatible with others
ABOUT	Mainframe production information	
	MDL###	Mainframe production model number
	SN: #####	Mainframe production serial number
	VER: 1.43	Mainframe software version
EXIT		

Table 3.10 System Menu Cont...

Configuration Menu

Press  +  to enter the **Configuration** menu.



Configuration Menu		
SYNC ON SET	Setup Synchronization ON / OFF function	
	ON (DEFAULT)	Turn on synchronization function
	OFF	Turn off synchronization function
VON		
	VON POINT	Set the load's Von point
	VON LATCH	Von latch state
		ON (DEFAULT) Turn on Von latch
		OFF Turn off Von latch
	EXIT	Exit the menu
AVERAGE COUNT	Average count setting 2 ^X (adjustable from 2 ² to 2 ¹⁶)	
V AUTORANGE	Auto switching voltage range	
	ON (DEFAULT)	Enable this function
	OFF	Disable this function
	ALIMIT POINT	Set up software current protection value
	ALIMIT DELAY	Set up software current protection delay
	PLIMIT POINT	Set up software power protection value
	PLIMIT DELAY	Set up software power protection delay
	ON TIMER STATE	Set up LOAD ON timer state
	ON TIMER SET	Set up LOAD ON timer time
	EXIT	Exit the menu

Table 3.11 Configuration Menu

Configuration Menu Cont...		
LIST		
	FUNCTION MODE	Select mode
		FIXED Choose fixed operation mode
		LIST Choose list operation mode
	RECALL LIST	Recall list operation file
	EDIT LIST	Edit list operation file
		HIGH RANGE Edit high range of list operation
		LOW RANGE Edit low range of list operation
EXT. CTRL SET	External analog control function	
	ON	Turn on external analog control function
	OFF (DEFAULT)	Turn off external analog control function
REM SENSE SET	Remote sense function	
	ON	Enable remote sense function
	OFF (DEFAULT)	Disable remote sense function
ABOUT	Module production information	
	MDL###	Channel production model
	SN:#####	Channel production serial number
	VER: 1.35	Channel software version
EXIT	Exit the menu	

Table 3.12 Configuration Menu Cont...

Automatic Test Menu

Press  +  to enter the **Automatic Test** menu.

Automatic Test Menu	
PROGRAM	
RUN PROGRAM	Run the testing file
RECALL PROG	Recall the testing file
EDIT PROGRAM	Edit the testing file
EXIT	

Table 3.13 Automatic Test Menu

Installation

4.1 Inspection

This instrument was carefully inspected before shipment. Upon receipt, inspect the instrument for damage that might have occurred during transit. If any sign of damage is found, please notify your B&K Precision distributor.

The following standard and optional accessories are provided with each mainframe or module.

Mainframes include:

- Power cord
- USB cable (MDL4U001 only)
- Mainframe extension cable accessory (MDL4U002 only)

Modules include:

- Certificate of calibration

NOTICE

Ensure the presence of all the items above. Notify your B&K Precision distributor if anything is missing.

4.2 Cleaning

Use a dry cloth or one slightly dampened with water to clean the external case parts. Do not attempt to clean internally.

WARNING

To prevent electric shock, please unplug the power cord connected to the unit before cleaning.

4.3 Installing Modules

CAUTION

Static electricity may damage load modules. Please install modules according to standard electrostatic prevention. Avoid touching joints and circuit boards.

Any combination of modules up to 2400 W total in the MDL4U001 mainframe in any order. This also applies to the MDL4U002 mainframe extension, allowing a maximum of 4800 W total when connecting the MDL4U001 and MDL4U002 together. The procedure of installing modules to the mainframe extension is the same as that of the MDL4U001 mainframe.

Installation Procedure

1. Turn the mainframe off and disconnect the power cord.
2. Remove the plastic cover with a flat-blade screwdriver.

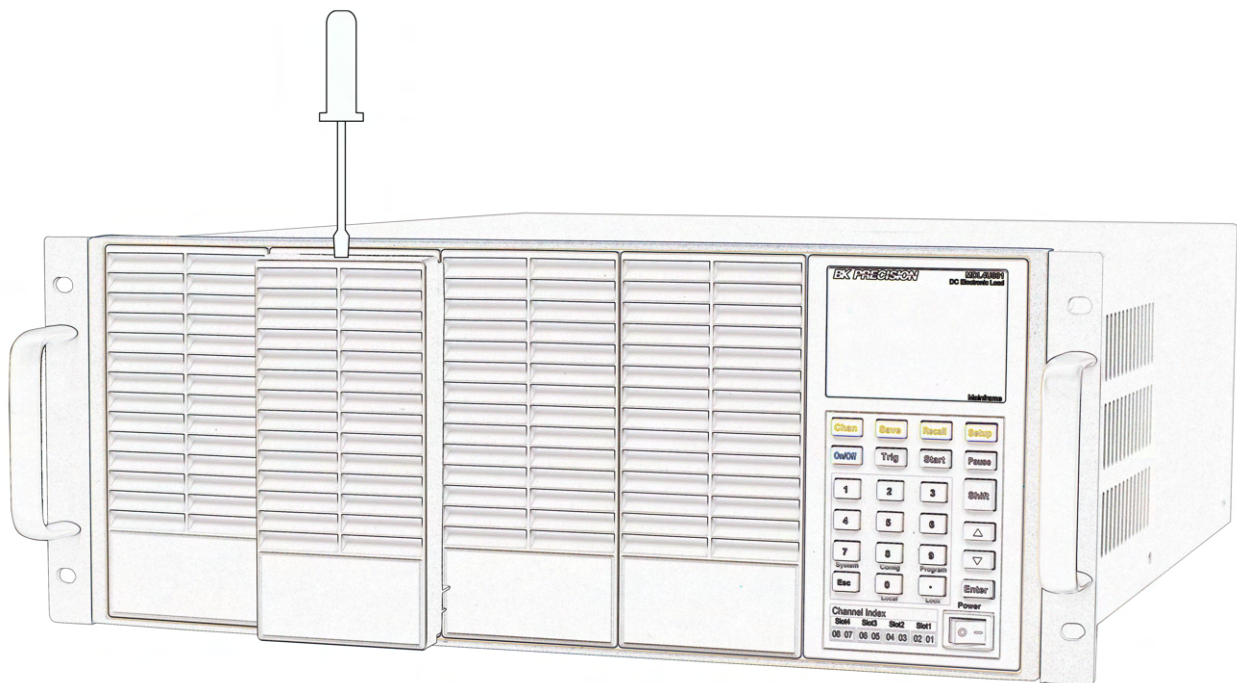

Figure 4.1 Removing Covers

3. Loosen the screws on the rear panel and remove the metal place holders.
4. Insert and slide the selected modules into the slot.
5. Insert and tighten module screws on rear panel.

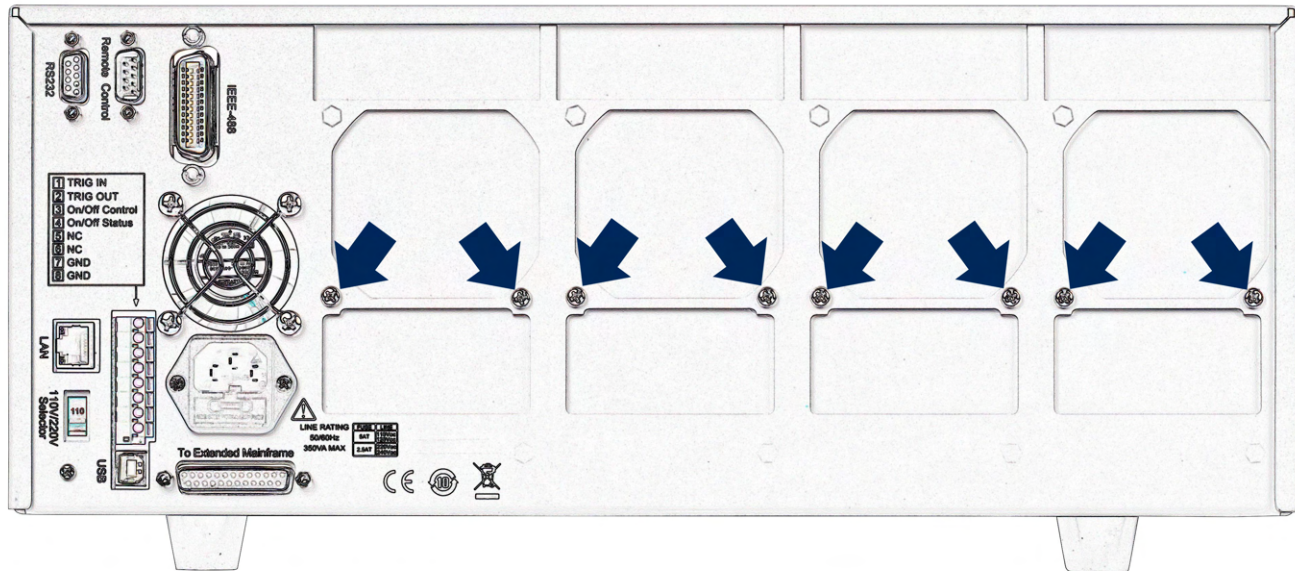

Figure 4.2 Removing Rear Cover Screws



Figure 4.3 Module Installation

6. Install more modules in other slots following the same process (stes 2 through 5).
7. Reconnect the power cord.

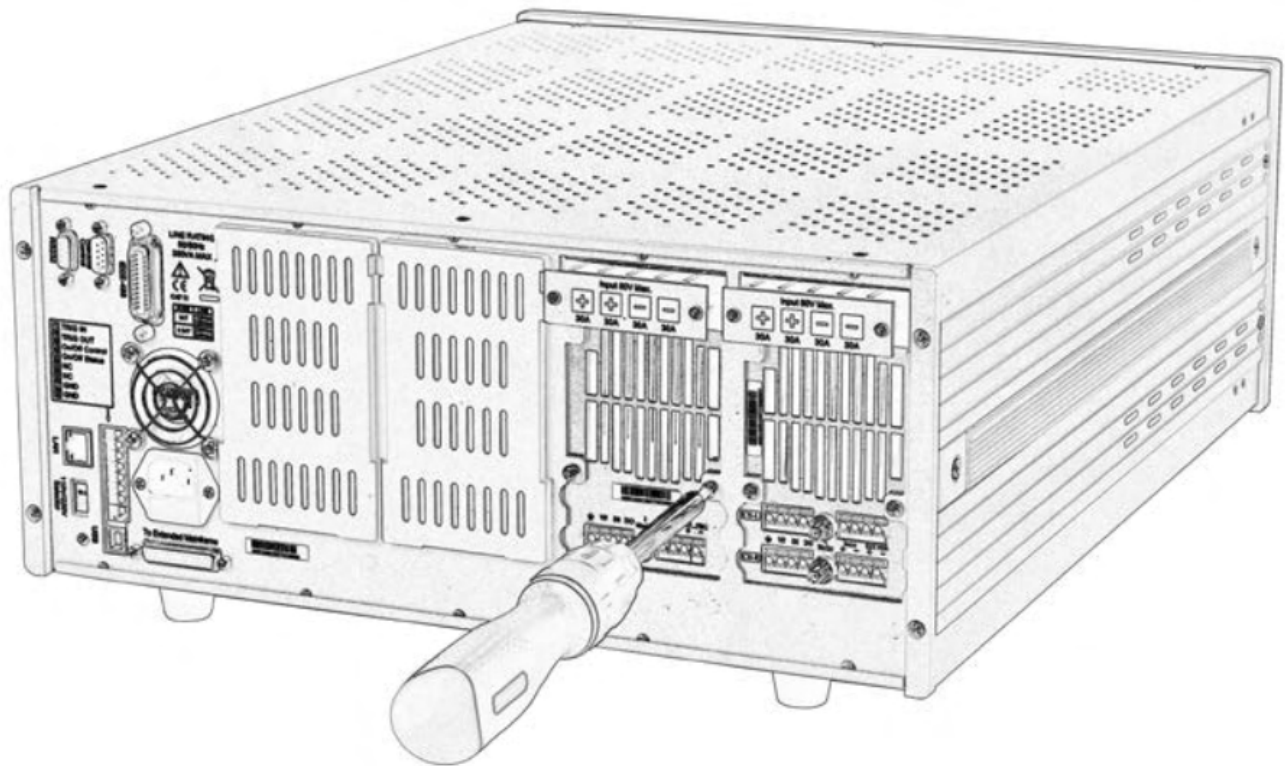

Figure 4.4 Tighten Module Rear Screws

4.4 Channel Number

The channel number for all modules is determined by the location of the modules in relation to the mainframe and ordered from right to left. With the MDL4U001 mainframe, the total number of channels is 8. Channels 1 and 2 are next to the mainframe front panel, while channels 7 and 8 are located on the left side. Load channel number is fixed even if the location is unoccupied. Dualchannel modules such as the MDL4U252 and MDL4U302 have two channels. If it is a single-channel module, the channel number is automatically assigned the first number of the slot. Figure 4.5 shows the default channel number order.

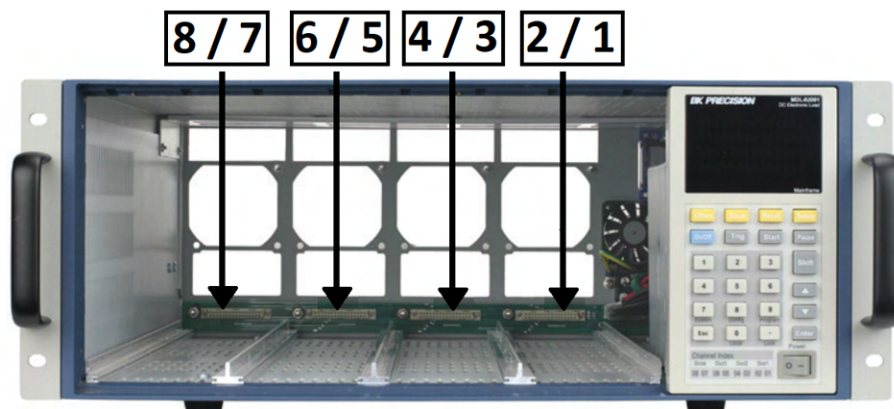

Figure 4.5 Channel Number

Figure 4.6 shows an examples of how channels are assigned when single-channel modules are installed.

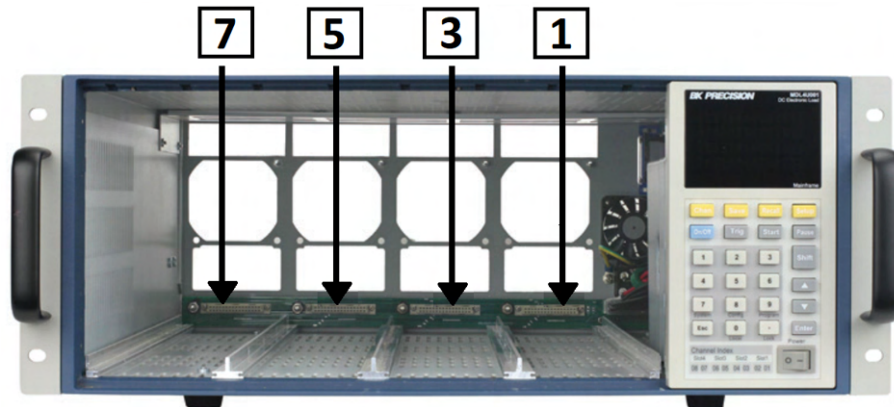

Figure 4.6 Single Channel Modules Numbering

Figure 4.7 shows an examples of how channels are assigned when single-channel modules and dualchannel modules are installed are installed.

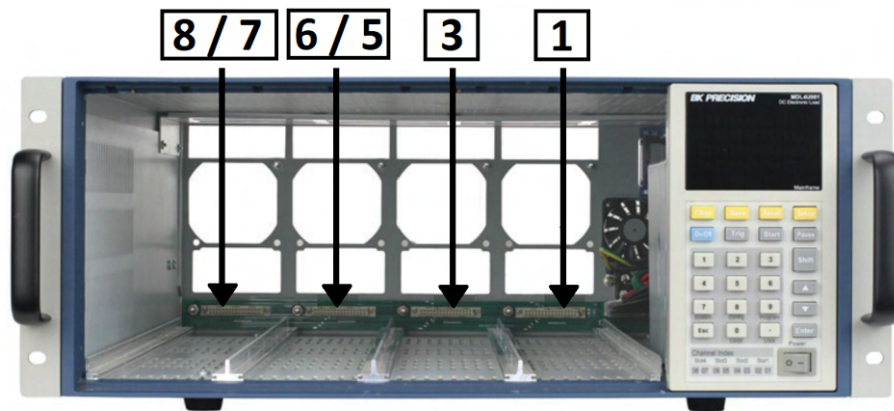

Figure 4.7 Single and Dual Channel Modules Numbering

4.5 Location

The operating temperature of the MDL4U Series DC Electronic Load is 0 to 40 °C. A fan cools the electronic load by drawing air through both the top and front, and then exhausting it out the back. Therefore, the electronic load must be installed in a location that allows sufficient space on the front and back of the unit for adequate air circulation.

Minimum clearances for bench operation are 2 inches from the top and 3 inches from the front and back. If there are radiator fans in your cabinet, please avoid installing the load near the fan, since it may limit air circulation of the load. If you are installing equipment on top of your electronic load in the cabinet, use a filler panel above the unit to ensure adequate air circulation.

CAUTION

Do not block the fan exhaust at the rear of the load. When the load is used on a bench, make sure there is enough space on the front and rear of the equipment for air circulation.

4.6 Input Voltage Selection

The electronic load can work under 110/220V±10% AC input, identified by an input line voltage switch on the rear (refer to Figure 4.8). If the indicated line voltage does not match your region, please use the switch in the back of the unit to choose your input line voltage, install appropriate fuse (refer to Table 4.2 below), and then insert power cord.



Check to make sure correct fuse is installed when line voltage is switched.

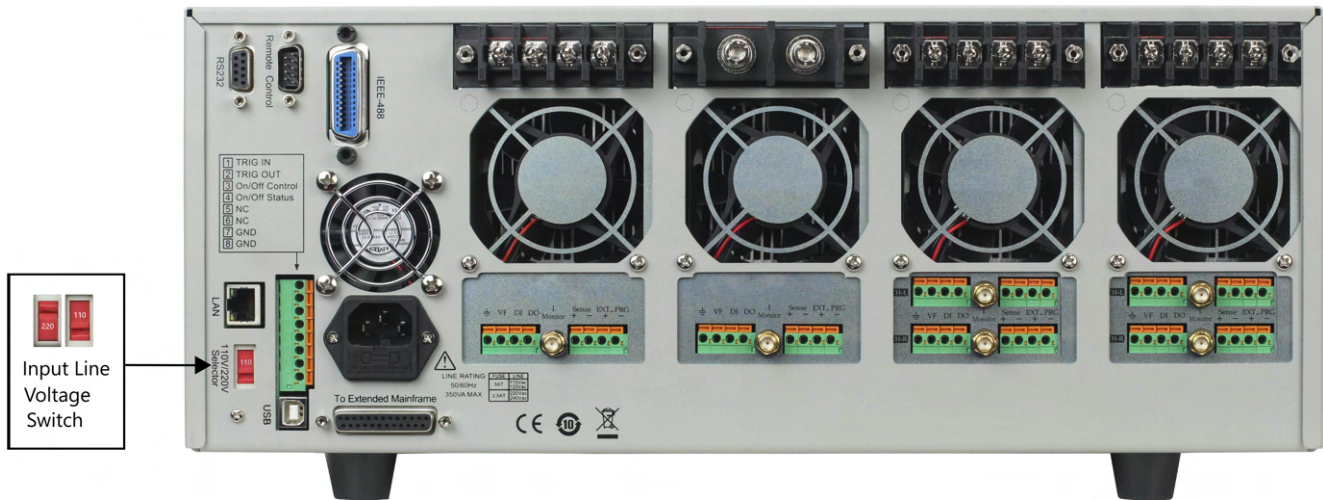

Figure 4.8 Input Voltage Selection

4.7 Turn-On Checkout

When you turn on the electronic load, the front-panel display will light up briefly while the electronic load performs its power-on self-test. The following table shows the procedure of the self-test.

Mainframe VFD Display	Description
BIOS Ver 1.20	VFD displays software version
SYSTEM SELF TEST	System self-check
CH1/2/3/4/5/6/7/8 SCAN... .7.5.3.1	Detecting all installed modules
e.g.CH01 CV OFF Vdc=0.0000V Adc=0.0000A Wdc= 0.00W	Displays information of channel 1 or the leftmost channel. Use up and down key to select other channels.

Table 4.1 Turn-On Procedure



Your electronic load is equipped with a 3-wire grounding type power cord; the third conductor being ground. The electronic load is grounded only when the power-line cord is plugged into an appropriate receptacle. Do not operate your power supply without adequate cabinet ground connection.

4.8 If the Electronic Load Does Not Turn On.

Use the following troubleshooting steps to help solve problems you might encounter when turning on the instrument:

1. **Verify that there is AC power to the electroic load.** First, verify that the power cord is firmly plugged into the power receptacle on the rear panel of the electronic load. You should also make sure the power source you plugged the electronic load into is energized. Then check to see that the electronic load is turned on.
2. **Verify the power line voltage setting.** The line voltage is set to the proper value for your country (110VAC or 220VAC) when the electronic load is shipped from factory. Change the line voltage setting if it is not correct.
3. **Verify that the correct power line fuse is installed and not burned out.** If fuse is blown, please replace it according to the following specification.

Product	Fuse specification (110 VAC)	Fuse Specification (220 VAC)
MDL4U001	T5A, 250 V	T2.5A, 250 V
MDL4U002	T5A, 250V	T2.5A, 250 V

Table 4.2 Fuse Specifications

4. Replace fuse.

Use a flat-bladed screwdriver to open the small plastic cover under the AC input connector on the rear panel of the load and then replace with matching fuse.

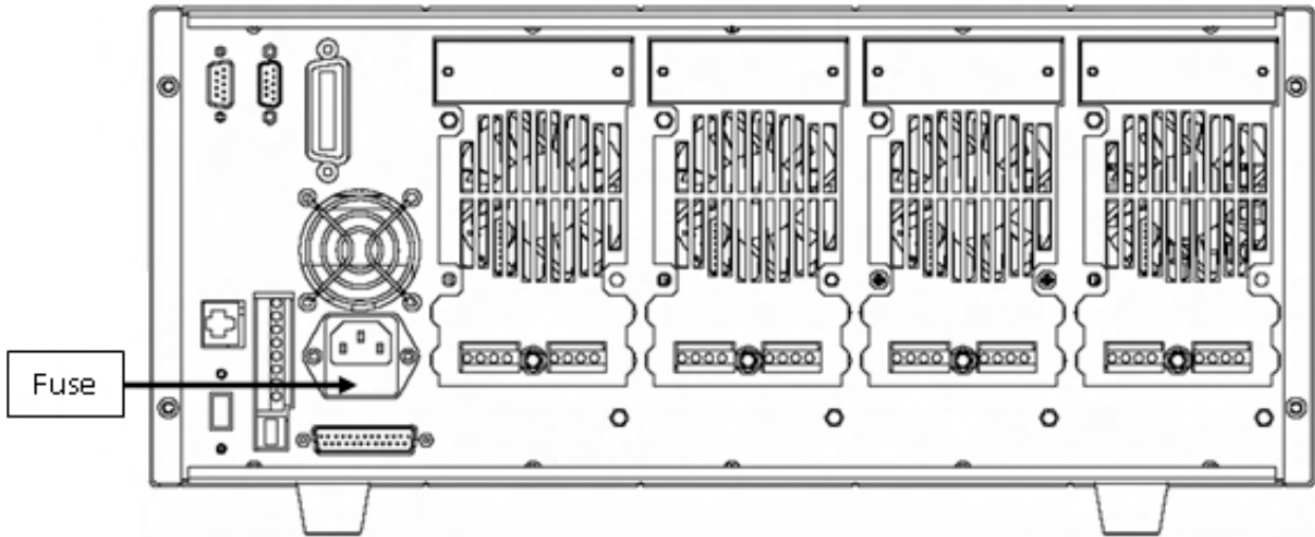

Figure 4.9 Fuse Location

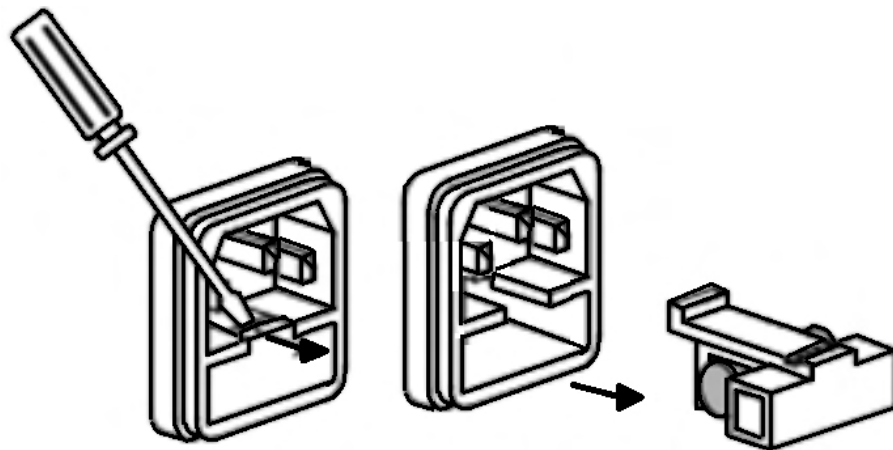

Figure 4.10 Fuse Removal

Load Connection

5.1	Parallel Connection	41
5.2	Mainframe 8-pin Control Connector	42
5.3	External Trigger Connections	43
5.3.1	Trigger Modes	43
5.4	External ON/OFF Control Connection	44
5.5	Mainframe Extension Connection	45
5.6	PC Control Connection	46



WARNING

To satisfy safety requirements, load wires between the electronic load and the device under test (DUT) should have a current rating high enough not to overheat while carrying the short-circuit output current. Never make connections between the electronic load and a DUT while the electronic load inputs are turned ON and/or the DUT has live power at its output.

Before connecting the device to be measured to the electronic load, please remove the cover on the output terminals of the load and cover it after completing the connection. Please pay attention to the type, length, and polarity when wiring. Avoid using wires of minimum specification of heating, which are unable to supply good load regulation.

Generally speaking, if the wires are short enough, they can control a voltage drop of less than 0.5 V. In addition, bonding them together can reduce induction and noise. Connect wire from positive terminal of module to positive terminal of device. Similarly, connect the corresponding negative terminal. Figure 5.1 illustrates a typical connection of the module with the device to be measured.

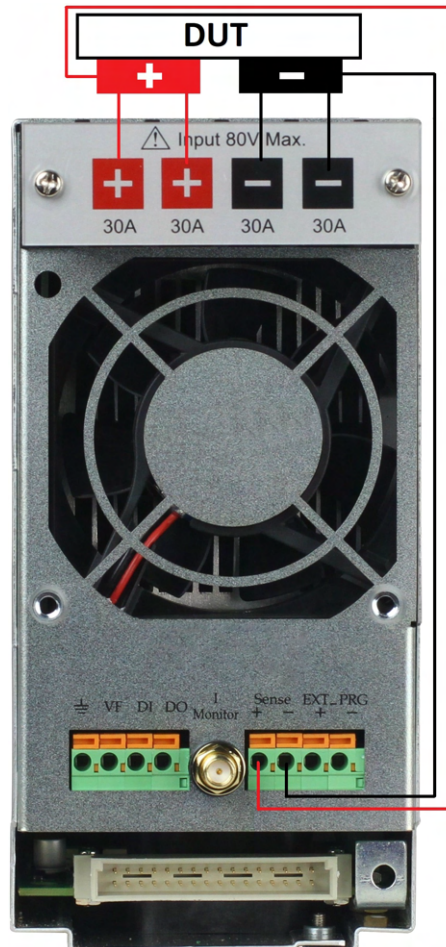

Figure 5.1 Module Input

There are two positive terminals and two negative terminals on the rear panel of every module. Single terminal connection is adequate when the input current is less than 30 A.

!WARNING

Each terminal can carry up to 30 A current. Double-terminal connection is needed when the input current is more than 30 A. Refer to Figure 5.1 - Connection of Load and Device Under Test (DUT) for double-terminal connection.

5.1 Parallel Connection

Parallel connection can be applied between modules of the same model to increase current and power dissipation, but **it cannot be applied between different modules**.

Modules can be paralleled in CC, CR, or CW mode, but **cannot be paralleled in CV mode**.

Each module will dissipate the power it has been programmed at. For example, after being paralleled, two single-channel modules rated at 80V/40A/300W can dissipate up to 80V/80A/600W.

Figure 5.2 illustrates the paralleled connection for increased power dissipation.

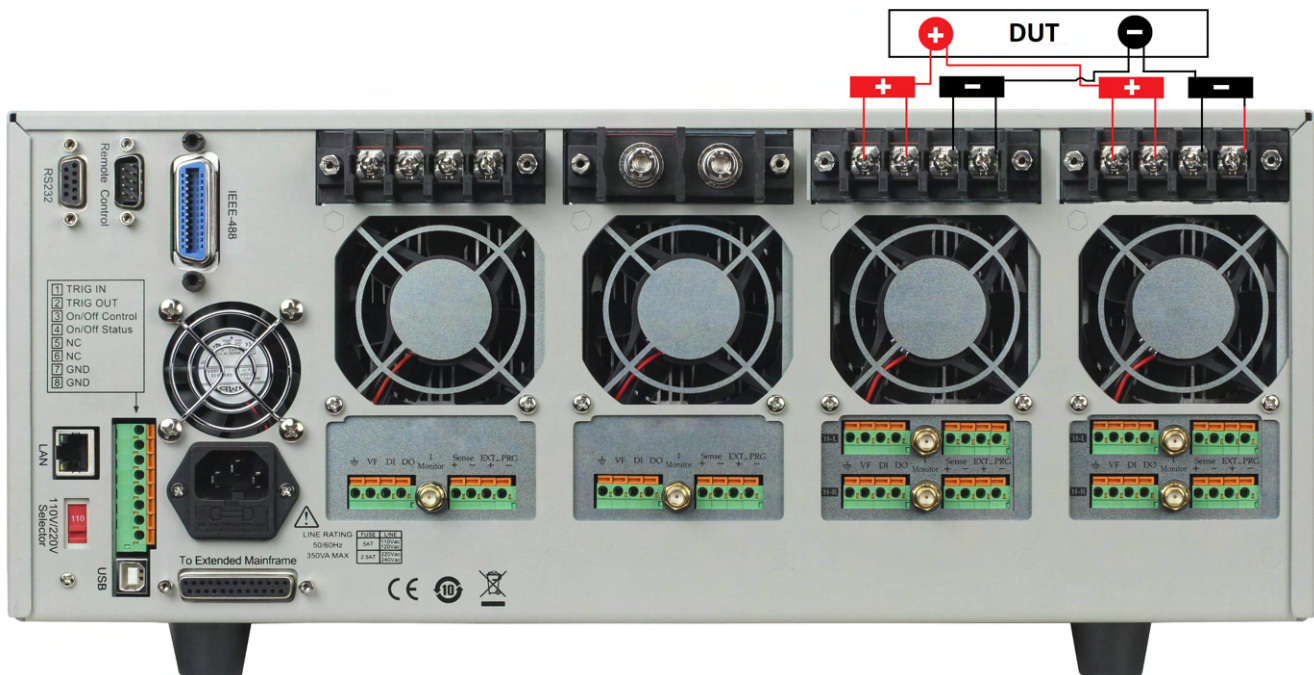

Figure 5.2 Parallel Module Connection

5.2 Mainframe 8-pin Control Connector

The mainframe’s 8-pin control terminal on the rear panel is shown below. This is used for external trigger and ON/OFF control connections.









Figure 5.3 Mainframe Rear Panel 8-pin Control Connector

Pin	Signal	Description
1	Trigger IN	Trigger Signal Input
2	Trigger OUT	Trigger Signal Output
3	ON/OFF IN	Synchronization ON/OFF Control Signal Input
4	ON/OFF OUT	Synchronization ON/OFF Signal Output
5	NC	No Connection
6	NC	No Connection
7	GND	Ground
8	GND	Ground

Table 5.1 Control Connector Pinout

5.3 External Trigger Connections

There is five kinds of trigger modes. To set the trigger mode:

1. Press the ( + ) to enter the **System** menu.
2. Press the   navigation keys to select **Trigger Source**.
3. Press the   navigation keys to select the desired trigger mode.

5.3.1 Trigger Modes

Manual Trigger Mode

To use the front panel trigger mode, set the trigger source to **MANUAL**.

Once trigger mode is set to manual press the .

External Trigger Mode

To use rear panel trigger mode, set the trigger source to **EXTERNAL**. Inputting a TTL level pulse (>10 us) to the trigger signal input (pin 1) of mainframe's **Mainframe 8-pin Control Connector** on the rear panel will enable a trigger operation. Figure 5.4 shows one way to produce a trigger signal.



Figure 5.4 Contact with a TTL Pulse Source

When making contact with a TTL pulse source, it produces a trigger to change the setting value (voltage, current, resistance, etc.), e.g. switch in transient mode, or create a pulse in dynamic pulse mode. At the same time, it will output a trigger signal on pin 2.

Hold Trigger Mode

To use hold trigger mode, set trigger source to **HOLD**. Then send the TRIG:IMM command to trigger the electronic load. Pin 2 of 8-pin Control Connector on the rear will also output a corresponding trigger signal when the electronic load receives the TRIG:IMM command.

Bus Trigger Mode

To use BUS trigger mode, set the trigger source to **BUS**. Connect the electronic load by GPIB, USB, or Ethernet communication interface.

When the TRIG command is received, the load will produce a trigger signal.

Timer Trigger Mode

To use timer trigger mode, set the trigger source to **TIMER**. Set the TRIGGER TIMER's time, and the electronic load will trigger at specified trigger timer setting and also produce a trigger signal on rear Trigger Out pin.

5.4 External ON/OFF Control Connection

ON/OFF IN (pin 3 of rear 8-pin Control Connector) is used to toggle the multi-channel electronic load inputs ON or OFF. When ON/OFF IN pin receives a TTL level pulse (>10us), the ON/OFF state of the load will toggle. SYNC ON SET function can be set to ON for multiple channels to toggle more than one channel at a time.

ON/OFF OUT (pin 4 of rear 8-pin Control Connector) indicates ON/OFF state of the multi-channel electronic load. If SYNC ON SET function of any specific channel is set to ON and the channel's input state is ON, pin 4 outputs a low TTL level signal. If the input state is off, pin 4 outputs a high TTL level signal.

5.5 Mainframe Extension Connection



Figure 5.5 Mainframe Extension Connection

The **Extended Mainframe** interface is used to connect the mainframe extension to expand the number of channels. Up to 16 total channels can be supported when mainframe is connected to the mainframe extension.





Procedure:

1. Use expansion cable to connect the mainframe extension interface between the mainframe and mainframe extension.
2. Press **Shift** + **7** to enter System menu.
3. Use the **▲** **▼** keys to navigate through menu.
4. Select **Expand Module** and choose ON to enable expand function.
5. Press Enter to confirm.

5.6 PC Control Connection

The MDL4U Series DC Electronic Load can achieve remote control via USB, RS-232, LAN, or GPIB interface, but only one interface can be used at a time.

To choose the interface:

1. Connect communication cable before powering on.
 - Do not hot plug, as it may damage the communication interface of the electronic load.
2. Power on the electronic load.
3. Select the channel number   via keys.
4. Press the  +  to enter the **System** menu.
5. Select **Communication** and select the desired interface.
 - Press Enter to confirm.
6. The display will return to the main menu.

NOTICE

When using RS232, GPIB, or LAN the communication settings must be set. To do so select RS232 Set, GPIB Address, or Ethernet Set from the system menu.

See the **Menu List** for full listing of menus and submenus applicable to all other remote interfaces.

Operations

6.1 Operation Modes

The electronic load has the following operation modes:

6.1.1	Constant Current (CC) Mode	47
6.1.2	Constant Voltage (CV) Mode	50
6.1.3	Constant Resistance (CR) Mode	52
6.1.4	Constant Power (CP) Mode	54
6.1.4.1	Setting CV,CC,CR, CW Mode	56

6.1.1 Constant Current (CC) Mode

In CC mode the electronic load will sink a current in accordance with the programmed value regardless of the input voltage.

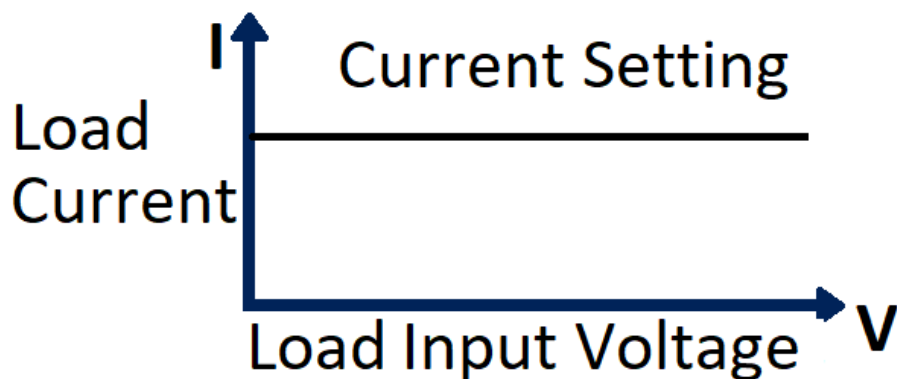



Figure 6.1 Constant Current Mode

CC Ranges

When working in CC mode, you can Press the the  key to enter the RANGE menu. Two overlapping ranges can be selected: LOW RANGE or HIGH RANGE. Current can be edited in either of the two ranges.

Low range will supply higher accuracy and better resolution when you set lower current. If any value you set is outside the maximum value of the LOW RANGE, you should select HIGH RANGE. If the electronic load is in remote control mode, you can use the CURR:RANG command to switch current range.

CC Vmax/Vmin Limits

The Vmax and Vmin parameters refer to the voltage high and low limit for the automatic test mode. During automatic test mode, the device test under test (DUT) must be operating within the configured values for the test to PASS upon completion. If the DUT operates outside the configured values, the test will FAIL upon completion.

NOTICE

These parameters are used for **Automatic Test ONLY**.

Immediate Current Value

Set the current level via front panel or by sending SCPI command CURR **n**. If the load is in CC mode, the new current level setting immediately changes the input at a rate determined by the slew rate. If the load is not in CC mode, the current level setting will be saved for use until mode is switched to CC mode.

Transient Current Level

A/B transient current level can be set on the front panel or by remote operation. The load can continuously toggle between the two levels when transient operation is turned on.

Set Slew Rate

The current slew rate determines the rate at which the input current to a module changes to a new programmed value. You can set the current level's rise/fall slew rate on the front panel or by remote operation. The programmed slew rate is immediately in effect to the triggered and transient current level changes.

Slew Rate Measurement and Actual Transition Time

Current slew rate is defined as the change in current over time. A programmable slew rate allows a controlled transition from one load setting to another. The actual transition time is defined as the time for the input to change from 10% to 90%, or 90% to 10% of the programmed current values. The graph below illustrates slew rate measurements.

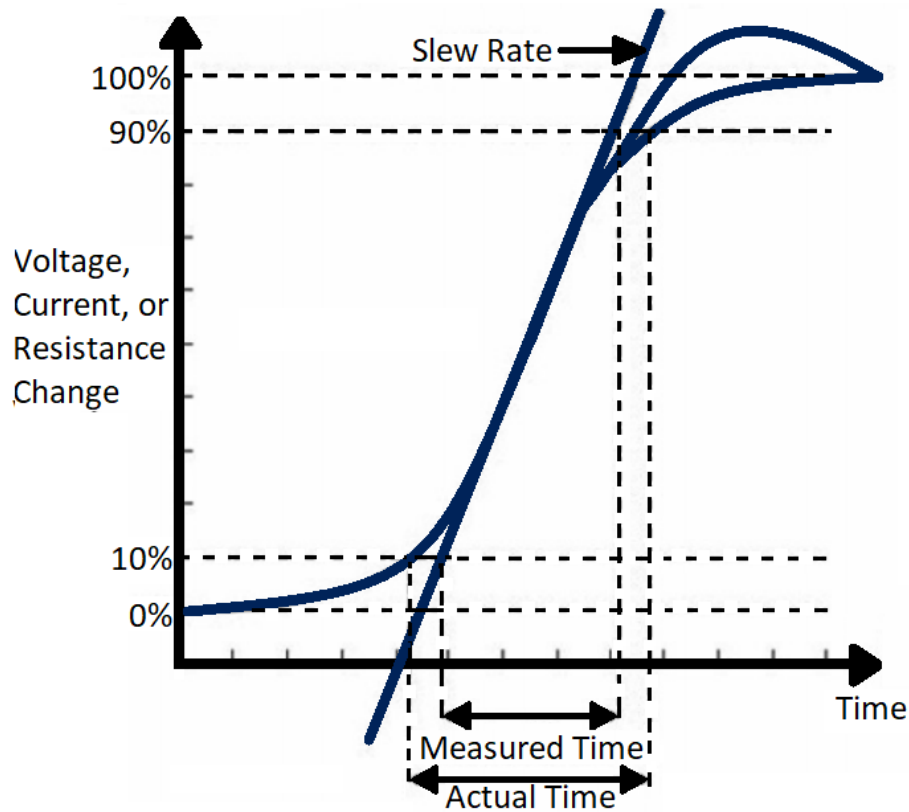

Figure 6.2 Slew Rate Measurement

Between the 10% and 90% region, the slew rate can be measured by observing the steepest slope portion. In case of very large load changes, e.g. from no load to full load, the actual transition time will be larger than the expected (measured) time. For this reason, the firmware allows the user to program slew rate values outside of the specified slew rate ranges. The minimum transition time for all programmable slew rates is also limited in cases where the transition from one setting to another is very small, due to bandwidth limitations of the load.

6.1.2 Constant Voltage (CV) Mode

In CV mode, the electronic load will attempt to sink enough current to control the source voltage to the programmed value.

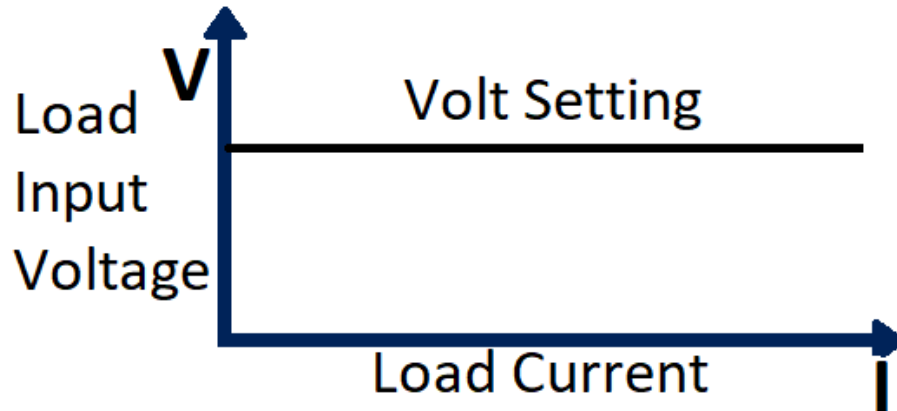

Figure 6.3 Constant Voltage Mode

CV Ranges

When working in CV mode, you can Press the the **Setup** key to enter the RANGE menu. Two overlapping ranges can be selected: LOW RANGE or HIGH RANGE. Voltage can be edited in either of the two ranges.

Low range will supply higher accuracy and better resolution when you set lower current. If any value you set is outside the maximum value of the LOW RANGE, you should select HIGH RANGE. If the electronic load is in remote control mode, you can use the VOLT:RANG command to switch voltage range.

Amax/Amin Limits

These parameters refer to the current high and low limit for the automatic test mode. During automatic test mode, the device under test (DUT) must be operating within the configured values for the test to PASS upon completion. If the DUT operates outside the configured values, the test will FAIL upon completion.

NOTICE

These parameters are used for **Automatic Test ONLY**.

Voltage Level

Set the voltage level on front panel or by sending SCPI command VOLT n. If the load is in CV mode, the new setting immediately changes the input. If the electronic load is not in CV mode, the set voltage level will be saved in the instrument for use until the mode is switched to CV mode.

Transient Voltage Level

A/B transient voltage level can be set on front panel or by remote operation. The electronic load can continuously toggle between the two levels when transient operation is turned on.

6.1.3 Constant Resistance (CR) Mode

In CR mode, the electronic load is equivalent to a constant resistance, as shown in figure 6.4. The electronic load will linearly change the current, according to the input voltage.

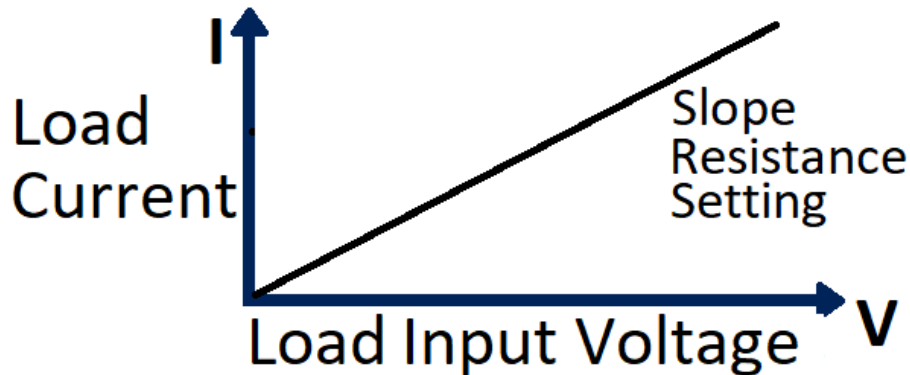



Figure 6.4 Constant Resistance Mode

CR Ranges

When working in CR mode, you can Press the the  key to enter the RANGE menu. Two overlapping ranges can be selected: LOW RANGE or HIGH RANGE. Resistance can be edited in either of the two ranges.

Low range will supply higher accuracy and better resolution when you set lower resistance. If any value you set is outside the maximum value of the LOW RANGE, you should select HIGH RANGE. If the electronic load is in remote control mode, you can use the RES:RANG command to switch resistance range.

CR Vmax/Vmin Limits

These parameters refer to the voltage high and low limit for the automatic test mode. During automatic test mode, the device under test (DUT) must be operating within the configured values for the test to PASS upon completion. If the DUT operates outside the configured values, the test will FAIL upon completion.

NOTICE

These parameters are used for **Automatic Test ONLY**.

Immediate Resistance Level

Set the resistance level via front panel or by sending SCPI command RES n. If the load is in CR mode, the new resistance level setting immediately changes the input. If the load is not in CR mode, the resistance level setting will be saved for use until mode is switched to CR mode.

Transient Resistance Level

A/B transient resistance level can be set on front panel or by remote operation. The load can continuously toggle between the two levels when transient operation is turned on.

6.1.4 Constant Power (CP) Mode

In CP mode, the electronic load will consume a constant power. When input voltage increases, the input current will decrease, while power ($P = V * I$) will remain the same.

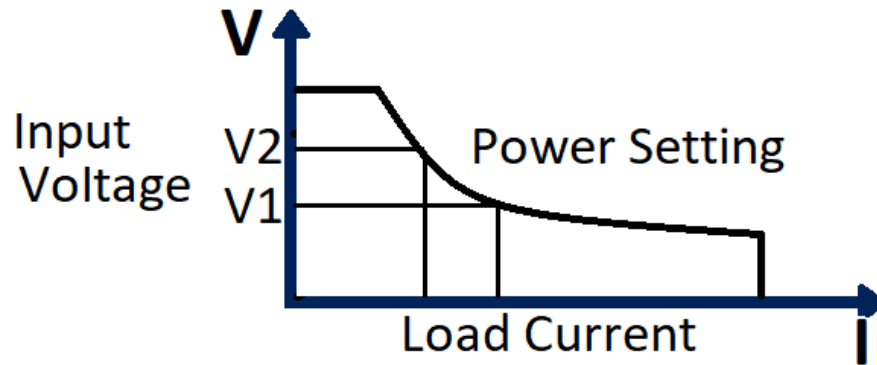

Figure 6.5 Constant Power Mode

CP Ranges

When working in CW mode, you can Press the the **Setup** key to enter the RANGE menu. Two overlapping ranges can be selected: LOW RANGE or HIGH RANGE. Power can be edited in either of the two ranges.

Low range will supply higher accuracy and better resolution when you set lower power. If any value you set is outside the maximum value of the LOW RANGE, you should select HIGH RANGE. If the electronic load is in remote control mode, you can use the POW:RANG command to switch power range.

CP Vmax/Vmin Limits

These parameters refer to the voltage high and low limit for the automatic test mode. During automatic test mode, the device under test (DUT) must be operating within the configured values for the test to PASS upon completion. If the DUT operates outside the configured values, the test will FAIL upon completion.

NOTICE

These parameters are used for **Automatic Test ONLY**.

Immediate Power Level

















Set the power level via the front panel. If the load is in CW mode, the new power level setting immediately changes the input. If the load is not in CW mode, the power level setting will be saved for use until mode is switched to CW mode.

Transient Power Level

A/B transient power level can be set via the front panel or by remote operation. The electronic load can continuously toggle between the two levels when transient operation is turned on.

6.1.4.1 Setting CV,CC,CR, CW Mode

To set up an operation mode from the front panel:

1. Power on the electronic load. Self-test
2. Press the  keys to select the channel to be edited, such as channel 1. CH01 CC OFF
3. Press the the  key to enter the channel setup menu.
4. Press the the  key to enter the **Mode** menu.
5. Press the the  key to select CV, CC, CR, CW mode.
 - Press the the  key to confirm.
6. Press the the  key to select the **Range** menu.
 - Press the the  key to confirm
7. Press the the  key to select **Low Range** or **High Range**.
 - Press the the  key to confirm
8. Press the the  key to select the voltage setting **Vset**, current setting **Iset**, resistance setting **Rset**, power setting setting.
 - Press the the  key to confirm.
9. Press the  key to select the rise slope setting f . Input the value and Press the
 - Input the value and Press the the  key to confirm. (CC mode only)
10. Press the the  key to select the fall slope setting f .
 - Input the value and Press the the  key to confirm. (CC mode only)
11. Press the the  key to exit.
12. Press the the  key to turn on the load's input.

6.2 Local Operations

6.2.1 Mainframe Panel

The front panel keys are effective only in the local mode. When the load is powered on, it works in local mode automatically (unless any of the remote interfaces are connected to a device controlling it). Select a channel number and set parameters such as voltage or current via the front panel keys. When the load is repowered on, the mainframe will scan all the installed modules once again, and can recall the parameters from the last time it was powered off.

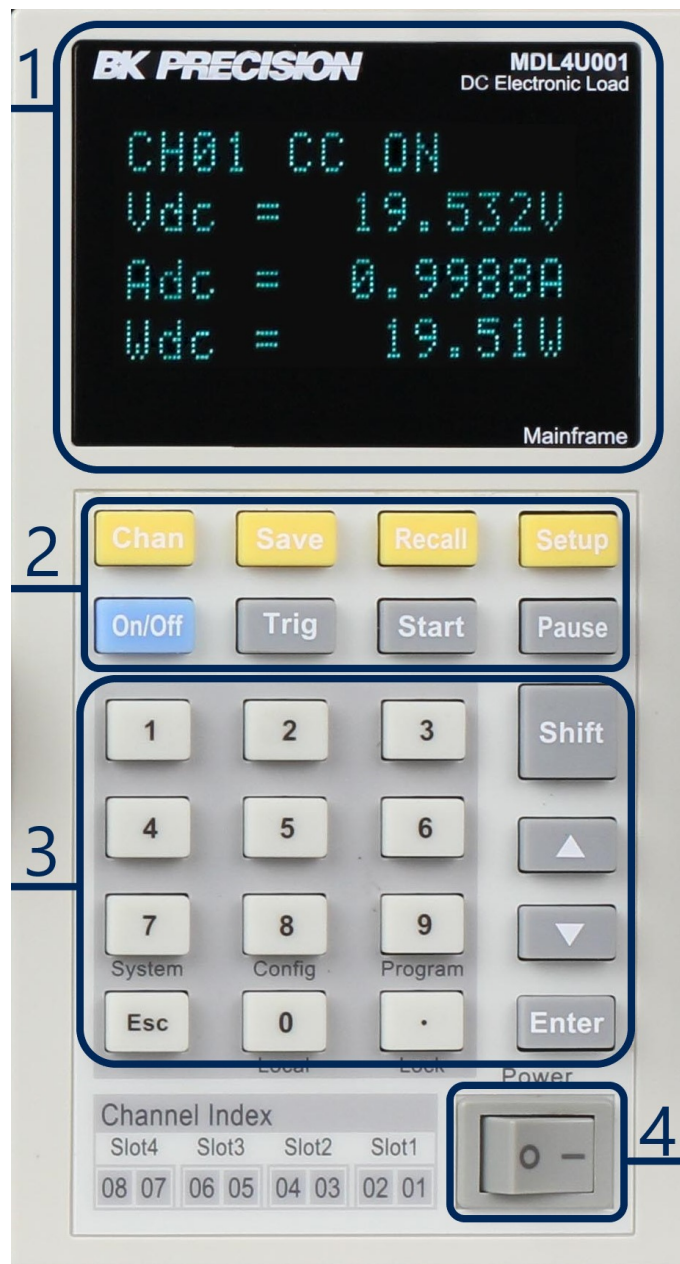

Figure 6.6 MDL4U001 Mainframe Front Panel

1. VFD Display

When powering on, the VFD screen will light up and show the instrument’s firmware version. Then the system will begin power-on self-test, check all the installed modules of the load, and display every channel’s number, voltage, and current measurements.

2. Function Keys

Key	Description
Chan	This key is used to switch channels. Every module has its own channel number and can be selected from the mainframe panel.
Save	This key is used to save parameters. After selecting a channel and editing its parameters, Press the the Save key to save your settings into non-volatile memory. Up to 101 groups of parameters can be saved.
Recall	This key can be used to quickly recall a saved group of parameters from memory.
Setup	This key is used to enter the specific channel’s menu. For example, Press theing this key allows you to set up A/B transient mode and CC/CV mode. For more details, view the Menu List section.
On/Off	This key is used to turn the module’s input state on or off. When the synchronization function in the channel menu is enabled, Press theing this key can control the on/off state of all channels.
Trig	This key is used to trigger the electronic load. Select the Manual Trigger mode to use front panel triggering.
Start	This key is used to start an automatic test.
Pause	This key is used to pause an automatic test. The VFD will display pausing at each step. Press the the key again to test the file continuously.

Table 6.1 Function Keys

3. Entry/Shift Key











Key	Description
Numeric Keys	These are number input keys.
	This key can be used to exit any working state.
	This key is used for decimal.
	These keys are used to move up and down the menu selection.
	This key is used to confirm selection.
	This key is used to enter other menus and functions.
 (System)	Press the this key combination to enter the System menu.
 (Config)	Press the this key combination to enter the Configuration menu.
 (Program)	Press the this key combination to enter the Program menu.
 (Local)	Press the this key to switch the electronic load to local mode when in remote sense mode.
 (Lock)	Press the this key to lock the module's panel keys and knob. RePress the the button to unlock.

Table 6.2 Entry/Shift Key

4. Power Switch

Turns the electronic load on or off.

6.2.2 Module Panel



Figure 6.7 Module Front Panel

1. **VDF Display:** Bright VFD display shows module's operating mode.

2. Panel Keys

Key	Description
A/B (single channel modules)	Switch A/B transient preset value.
L/R (dual-channel modules)	Switch the left/right channels. Press the this key + rotary knob to control the two channels.
Short	Used for short testing. This allows the load to simulate a short circuit at the input.
Mode	Switches the operating mode (CC, CR, CV, or CW).
	Move the cursor position. Press the key to move the cursor to the position you want to edit, and then use the rotary knob to adjust value.
Tran	Selects the transient mode. Press the this key first to enable transient mode before running A/B transient operation and then send the triggering signal to run a program.
On/Off	Control module's input on/off state

Table 6.3 Entry/Shift Key

3. Rotary Knob Used to change parameter values.





4. Air Inlet

Module's air inlet for cooling purposes.





Do not place any objects that may block or cover air inlet.

6.2.3 Module Panel Lock

Press the the  +  keys to lock the selected channel's keys and knob operation. To unlock, Press the the  +  again.



6.3 Switching Channels

There are three ways to switch channels:

1. Press the the  + **number** keys.
2. Press the the  +  keys.
3. Press the the number key of the channel in the **Setup** menu.

6.4 Channel Synchronization

To change the synchronization of the channels:

1. Switch to the channel on the mainframe.
2. Press the  +  key to enter the **Configuration** menu.
3. Select and enter the **SYNC ON SET** submenu.
4. Select **ON** or **OFF**.
5. When enabled, the  key can control the input state of the corresponding module synchronously.

NOTICE

The same method can be used to set up synchronization with other channels. When in remote control mode, the SCPI command INPut:ALL ON is used to synchronously load all channels.

6.5 Module VFD Indicator Function Description

Figure 6.8 indicates

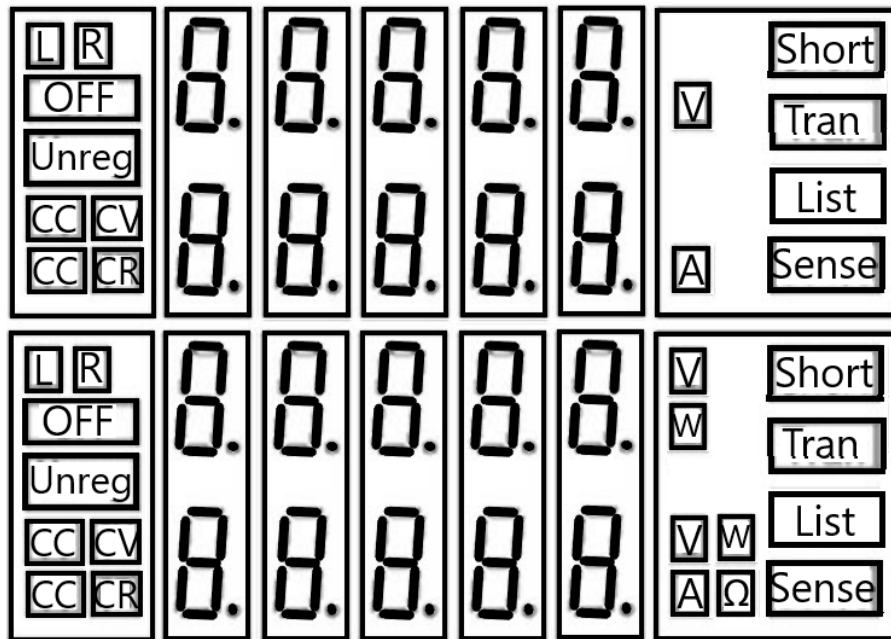

Figure 6.8 Load Module VFD Panel

L/R

The indicator of the dual-channel module's left/right channel. If you want to edit left/right channel parameters, first select the channel using the L/R key. Single-channel module will always display R.

OFF

Indicates that the module input is off. When module input is enabled, OFF indicator will turn off.

CC/CV/CR/CW

Indicates the module's operating mode.

VFD Display Screen

Shows four lines of numbers. The first line shows the measured voltage value. The second line shows the measured current value. The third line shows the measured circuit's power value. The fourth line shows the setup value, and users can set A/V/Ω value here.

Short

Is displayed when short circuit function is enabled on the module.

Tran

Is displayed when TRANSIENT mode is enabled on the module.

List

Is displayed when selecting LIST mode in the Configuration menu.

Sense

Is enabled in remote sense function. There is no need to set this in the menu, as you only need to link the circuit to remote sense terminals and 'Sense' will be displayed.

6.6 Transient Operation

Transient operation enables the module to periodically switch between two load levels, as might be required for testing power supplies. Transient operation can be turned on and off from the front panel (Tran and Trig keys). The parameters of the transient operation include: A level, A width, B level, B width, and transient testing modes.

There are three different transient testing modes: continuous, pulse, and toggle.

Mode	Description
Continuous	Generates a respective pulse stream that toggles between two load levels.
Pulse	Generates a load change that returns to its original state after some time period.
Toggle	Generates a repetitive pulse stream that toggles between two load levels. It is similar to continuous mode except that the transient points are controlled by explicit triggers instead of an internal transient generator.

Table 6.4 Transient Modes

6.6.1 Continuous

The electronic load generates a repetitive pulse stream that toggles between two load levels. The load switches the state between two value settings, value A and value B.

In CC mode, transient testing can be used to check the stability of the source voltage. Transient functions have two current levels (A level, B level), which should be in the same range (high range or low range). You can set the A/B level delay time and the rise/fall slew rate via the mainframe keypad.

The slew rate determines the rate at which the level changes. Press the Trig key, and the load will continuously switch between the A/B levels preset. Transient loads are usually used to test the power supply's performance under continuous changing load conditions. Figure 6.9 shows the current waveform of continuous transient operation mode.

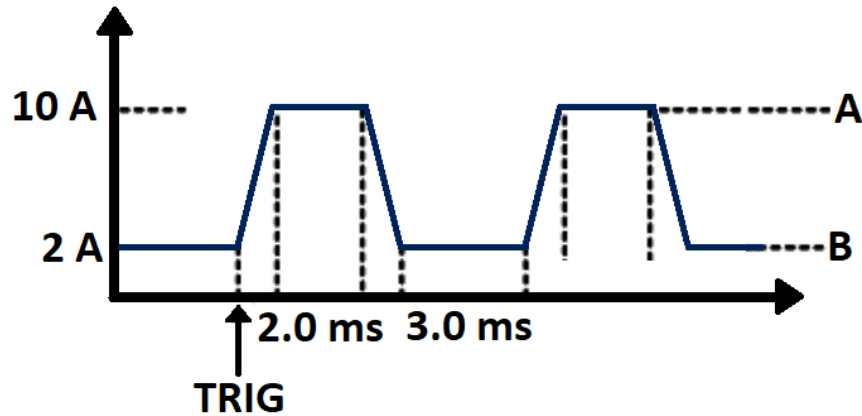

Figure 6.9 Continuous Transient Operation

6.6.2 Pulse

The electronic load generates a transient pulse of programmable width when pulse transient operation is in effect.

In pulse mode, you can set A/B level, A/B width, and A/B slew rate via the mainframe keypad. The electronic load will automatically switch to A level after maintaining A width time. Then it will switch to B level. The electronic load will not switch to A level again until the instrument receives the pulse signal. The figure 6.10 shows the current waveform in pulse transient operation.

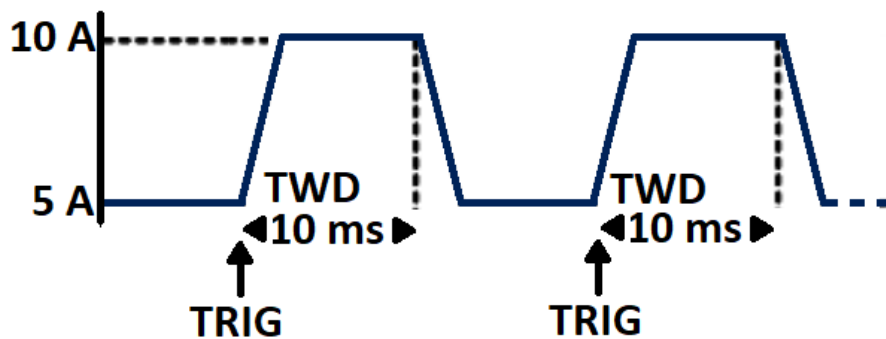

Figure 6.10 Pulse Transient Operation

6.6.3 Toggle

The electronic load will switch between A level and B level when receiving a trigger signal after the transient operation is enabled. The following picture shows the current waveform in toggle transient operation.













Figure 6.11 Toggle Transient Operation





























6.6.4 Setting Up A/B Transient Operation

The following is a short tutorial of how to set up A/B transient operation for the electronic load. In this example, the up rise speed is set to 1 A/us and fall speed is set to 2 A/us. The electronic load will be in continuous transient mode and switch between 10 A and 2 A in durations of 0.002 s and 0.003 s respectively.

NOTICE

When setting up steps, make sure all transient level, slew, and width parameters are within the modules' specified limits.

1. Power on the electronic load.
2. Press the  keys to select the channel to be edited. In this example, we select channel 1.
3. Press the  to enter the channel setup menu.
4. Select **Mode** and Press the  to change the operating mode to CC mode. Press the  to confirm.
5. Press the  key to select **Range** setting and press the  key.
6. Press the  key to select **LOW RANGE** and press the  key to confirm.
7. Press the  key to select the rise slope setting f and press the .

- For 1A/us, input 1 and Press the  key to confirm.
8. Press the  key to select the fall slope setting f and press the  key.
For 2A/us, input 2 and Press the  key to confirm.
9. Press the  key to select A level setting **TRANa** and press the  key.
For 10A, input 10 and Press the  key to confirm.
10. Press the  key to select A width setting **Ta** and press the  key.
For 0.002s, input .002 and Press the  key to confirm.
11. Press the  key to select B level setting **TRANb** and press the  key.
For 2A, input 2 and Press the  key to confirm.
12. Press the  key to select B width setting **Tb** and press the  key.
For 0.003s, input .003 and Press the  key to confirm.
13. Press the  key to select transient operation mode **Tmode** and press the  key.
14. Select **Continuous** and press the  key to confirm.
15. Press the  key to exit.
16. Press the  +  to enter the **System** menu.
17. Press the  key to select **Trigger Source** and press the .
18. Select **Manual** and press the  key to confirm.
19. Press the  key to exit.
20. Press the  key to turn on the electronic load's input.
21. Press the  key on channel 1 module to enable transient operation.
22. Press the  key on mainframe panel to trigger transient operation

Transient Operation Programming Example

In remote mode, the following commands can be used to setup the same parameters used in the tutorial above. (refer to MDL4U Series Programming Guide for more information).

CURRent:TRANsient:MODE CONTInuous

CURRent:TRANsient:ALEVel 10

CURRent:TRANsient:AWIDth 0.2ms

CURRent:TRANsient:BLEVel 2

CURRent:TRANsient:BWIDth 0.3ms

TRANsient ON

TRIGger:IMMediate

6.7 List Operation

List mode lets you generate complex sequences of input changes on a single channel with rapid and precise timing, which may be synchronized with internal or external signals. This is useful when running test sequences with a minimum amount of overhead.

The parameters of List operation include the name, number of steps (2-84), step width time (20 us - 3600 s), and every steps' set value and slew rate. The list file can be saved in non-volatile memory where it can be quickly recalled. Up to 7 groups of List files in CC mode only can be edited.

In List operation mode, the electronic load begins to enable the List operation when it receives the trigger signal and will continue until the List operation is completed or the instrument receives another trigger signal

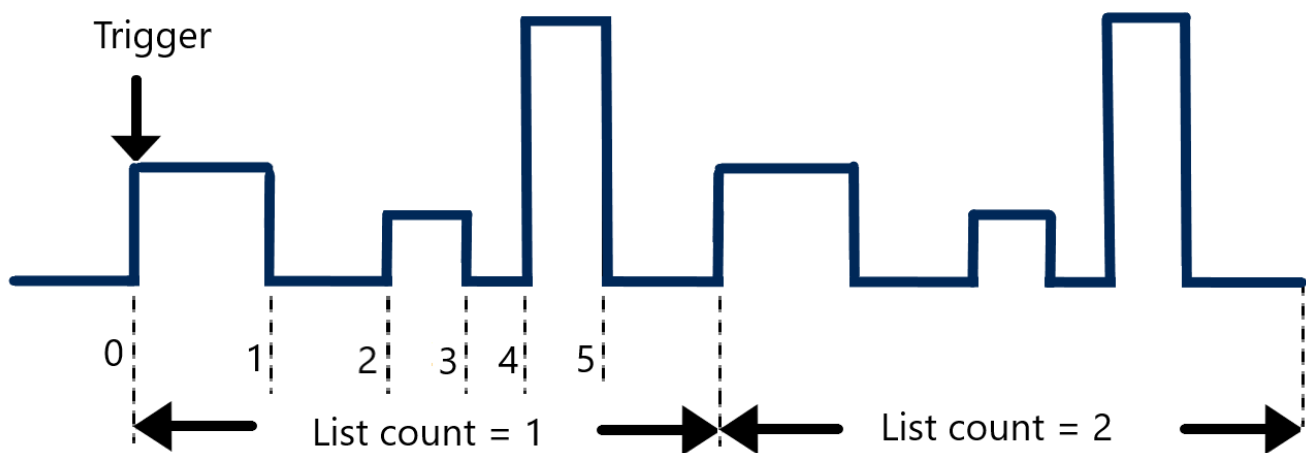



























Figure 6.12 List Operation

6.7.1 Setting Up List Operation Mode

The following is a quick tutorial of how to set up List Mode for your electronic load.

1. Power on the electronic load.
2. Press the   keys to select the channel to be edited.
3. Press the  +  to enter the **System** menu.
4. Press the  key to select **Trigger** source and press the  key.
5. Select **Manual** and press the  key to confirm.
6. If electronic load is on, press the  key to turn off the electronic load's input.
7. Press the  +  to enter the **Configuration** menu.
8. Press the  key to select **List** and press the  key.
9. Press the  key to select **Edit List** and press the  key.
10. Press the   key to select high range or low range and press the  key to confirm.
11. Input number of steps in the List.
Input value and press the  key to confirm.
12. Set first step's current level. Input value and press the  key to confirm.
13. Set first step's slew rate. Input value and press the  key to confirm.
14. Set first step's width time. Input value and press the  key to confirm.
15. Set second step's current level. Input value and press the  key to confirm.
16. Set second step's slew rate. Input value and press the  key to confirm.
17. Set second step's width time. Input value and press the  key to confirm.
18. Set parameters for steps 3 through 5 in the same manner described above.
19. Set number of run cycles. Input value and press the  key to confirm.

20. Select memory position to save list file. Input value and press the  key to confirm.

21. Press the  key to select **Function Mode** and press the .

22. Select **List** and press the  to confirm.

23. Press the  key twice to exit menus.

24. Press the  key to turn on the electronic load's input.

25. Press the  key to trigger List mode operation.

6.8 Trigger Operation

The trigger operation can be used in the following operations: transient pulse output, triggered output, and list output. The electronic load has five kinds of trigger modes to synchronously trigger the tested instrument. Before enabling the trigger function, the trigger source must be selected.

6.8.1 Manual Trigger

When manual trigger mode is active, pressing the Trig key on the front panel will enable a trigger operation.

6.8.2 External Trigger Signal(TTL level)

The 1st pin of the 8-pin connector on the rear panel of the mainframe is the trigger input terminal. When an external trigger signal is available, input a low pulse (>10us) to the input and the load will enable a trigger operation.

6.8.3 Hold Trigger

When hold trigger is used, the load will enable a trigger operation only when the load receives the TRIG:IMM trigger command from the communication port.

6.8.4 Bust Trigger

When bus trigger is set, the load will enable a trigger operation as soon as the load receives the trigger command GET or *TRG.

6.8.5 Timer Trigger

When timer trigger is set, the mainframe will enable a trigger operation periodically.

6.9 Short Operation

The electronic load can simulate a short circuit at its input. During front panel operation, press the  key to switch the short on/off state. Short operation will not affect the present setting. When turning off the short state, the load returns to the original set state.

The actual value of the electronic load in short operation depends on the mode and range that is active when the short is turned on. In CC or CR mode, the maximum short current is 120% of the current range. In CV mode, short means setting the load's constant voltage to be 0 V. In short operation mode, you can measure the maximum short current (Amax) or DC current (ADC) of the power source to be measured. This function via the Configuration menu. When in remote control mode, send the SCPI command INPut:SHORT ON to enable the short operation.

6.10 Input On/Off Operation

During front panel operation, press the  key to switch the input on/off state. Input On/Off operation will not affect the present settings. The load/unload speed of On/Off operation is not dependent on the rise/fall slew rate. When in remote control mode, send the SCPI command "INPut ON" to turn the input on (refer to MDL4U Series Programming Guide for more information on remote commands).

6.11 Von Operation

The Von voltage value can be set to control the voltage turn on state for the electronic load. When the input voltage exceeds the Von voltage value, the electronic load's input state turns on.

This function can protect a DUT when its voltage goes below a specified level. For example, when testing a power supply's discharge, you can set the voltage level for the power supply to begin and end discharging.

There are two different modes of Von operation, set by the Von LATCH parameter. When Von LATCH is disabled, the electronic load will begin sinking current if input voltage exceeds Von voltage. When the input voltage drops below the Von voltage value, the electronic load will stop sinking current and the input will turn off.

When Von LATCH is enabled, the electronic load will begin sinking current if input voltage exceeds Von voltage. When the input voltage drops below the Von voltage value, the electronic load will still continue to sink current and the input remains on.

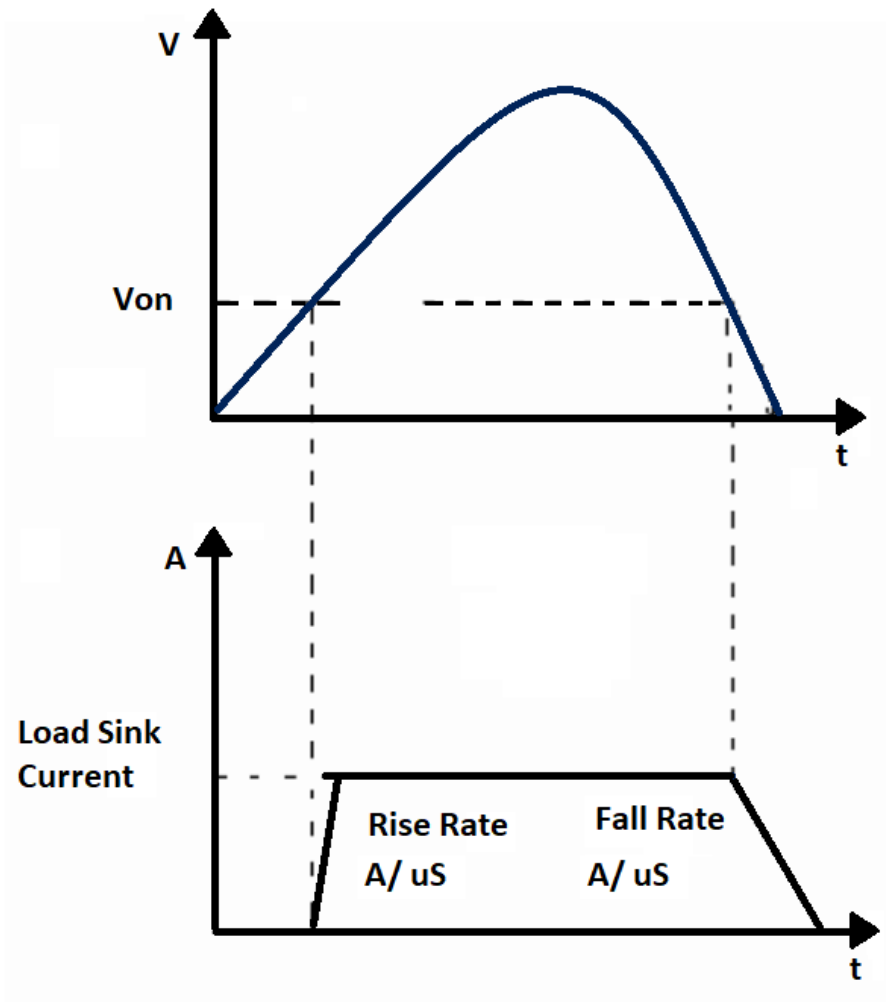

Figure 6.13 Von LATCH Load's Working Range

Setting Up the Von Function

The following is a quick tutorial of how to set up the Von function for your electronic load. In this example, Channel 1 Von is enabled and set to 5 V.

1. Power on the electronic load. Self-test
2. Select channel to be set up. Press the 1 for channel 1.
3. Press the **Shift** + **8** to enter Configuration menu.
4. Press the **▼** to select **Von** and press the **Enter**.
5. Select **Von Point** and press the **Enter** key.
6. Set the Von Point. Input 5 and press the **Enter** to confirm.

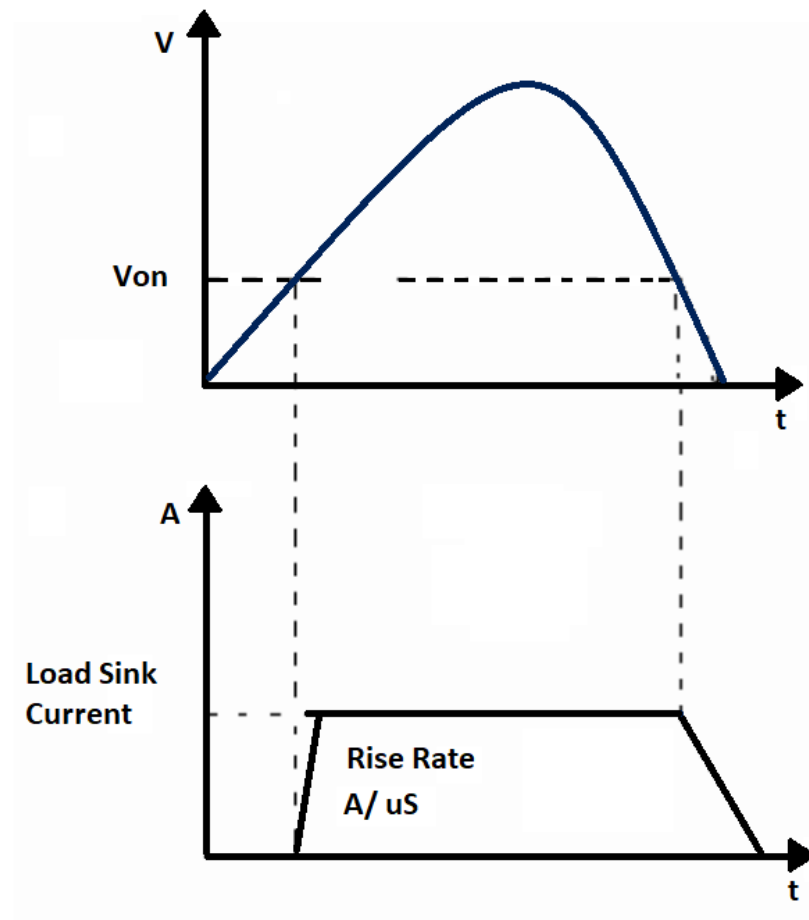







Figure 6.14 Von LATCH Load's Working Range

7. Press the  key to select **Von Latch** and press the  key.
8. Select On and press the  key to confirm.
9. Press the  key twice to exit menus.
10. Press the  key to turn on the electronic load's input. The electronic load will begin sinking current at 5 V.

When in remote control mode, you can send SCPI command "VOLT:ON **n**" to set Von value; send "VOLT:LATch ON" to enable Von LATCH function.



6.12 Save and Recall Operation

The stored settings of all channels can be recalled. The stored parameters include operation mode, voltage/current values, slew rate, transient setting, and more. Up to 101 groups of setting parameters can be saved. Group 0 can be used for power-up settings. Groups 1 through 100 can be used for automatic testing parameters. All parameters are saved into non-volatile memory and will remain saved even in a powered down state.

To save the channel's settings:

1. After setting up your parameters, press the  key to save. It will ask for the Save Group number.
2. Input the Save Group number (0-100) and press  to confirm.

To recall previously saved settings:

1. Press the  key. It will ask for the Recall Group number.
2. Input the Group number (0-100) you previously saved your parameters to and press  key to recall.

6.13 Module Controlling Link

There is an 8-pin terminal and current monitoring connector on every module's rear panel.

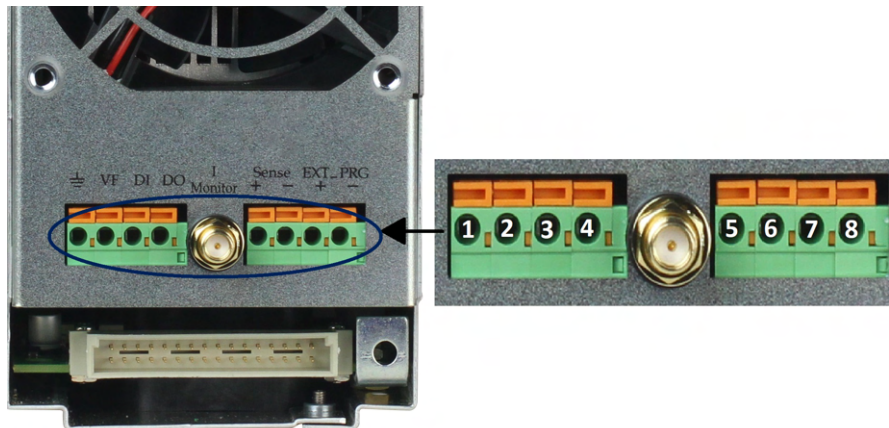

Figure 6.15 Single-Channel Control Module Link

Pin	Signal	Description
1	GND	Ground
2	VF	Voltage fault indication terminal
3	DI	Digital input terminal
4	DO	Digital output terminal
	I OUT	Current monitoring output
5	SENSE +	Voltage remote measuring terminal (+)
6	SENSE -	Voltage remote measuring terminal (-)
7	EXT_PRG+	External analog controlling terminal (+)
8	EXT_PRG-	External analog controlling terminal (-)

Table 6.5 Module Terminal Pinout

6.13.1 Voltage Failure Indication

When the electronic load is under OVP or reverse protection condition, pin 2 (VF) will output a high level signal.

6.13.2 Current Monitoring

The current monitoring terminal will output 0-10 V analog signal accordingly to 0 - full range of the input current. You can connect an external voltmeter or an oscilloscope to display the input current's change.

6.13.3 Digital I/O

Digital I/O is pin 3 and pin 4 shown in figure 6.15 and only used in remote control. The digital input terminal (pin 3) can detect a high/low level signal. The digital output terminal (pin 4) can output a TTL high/low level signal. It is a universal output terminal and can be used to control an external instrument.

6.13.4 Remote Sense Function

When working in CC, CV, and CR mode, if the electronic load consumes a very large current, it will cause a voltage drop in the leads between the connected device and terminals of the electronic load. In order to ensure testing accuracy, the electronic load provides a pair of remote sensing terminals in the rear panel where users can sense the output terminal voltage of the connected device. Set the electronic load to **REMOTE SENSE** mode before using this function. On the rear terminals, SENSE (+) and SENSE (–) are the remote sensing inputs. By eliminating the effect of the voltage drop in the load leads, remote sensing provides greater accuracy by allowing the electronic load to regulate directly at the source's output terminals (see Figure 5.1).

6.13.5 External Analog Control

Controls the current setting of the electronic load in CC mode using the external analog programming terminal, pin 7 and pin 8. A 0-10 V input signal will simulate 0 – full scale of the electronic load to regulate the input current of the electronic load (10 V indicates the full range of electronic load's current rating)

Note:

External analog control is designed to be used when the instrument is set to High range (full range) only. If low range is used, the 0-10 V input signal may not reflect the full scale input range of the load.

6.14 Automatic Test

The automatic test function of the MDL4U Series electronic load is useful for simulating various tests and allows the user to edit up to 10 program files. Each file has 10 steps and up to 100 steps can be edited and saved into the EEPROM. Convenient for production environments, automatic test can cascade sequences across multiple channels and allows setting of Pass/Fail (P/F) criteria.

6.15 Configuring Pass/Fail Parameters

The Pass/Fail criteria can be found in the **SETUP** menu of the front panel, under the Vmax/Vmin (CC/CR/CW mode) or Amax/Amin (CV mode) parameters. Set Pass/Fail criteria for each mode used in the Automatic test sequence before running the automated test.



6.15.1 Configuring Instrument Settings

























The automatic test runs a program that uses the settings stored into the internal EEPROM memory. Each program can run 10 sequences, and each of these sequences is correlated to instrument settings that are stored within a designated group of internal EEPROM memory. They are designated according to the table below:





Save Table										
PROGRAM 1 Sequence	1	2	3	4	5	6	7	8	9	10
Save Group	1	2	3	4	5	6	7	8	9	10
PROGRAM 2 Sequence	1	2	3	4	5	6	7	8	9	10
Save Group	11	12	13	14	15	16	17	18	19	20
PROGRAM 3 Sequence	1	2	3	4	5	6	7	8	9	10
Save Group	21	22	23	24	25	26	27	28	29	30
PROGRAM 4 Sequence	1	2	3	4	5	6	7	8	9	10
Save Group	31	32	33	34	35	36	37	38	39	40
PROGRAM 5 Sequence	1	2	3	4	5	6	7	8	9	10
Save Group	41	42	43	44	45	46	47	48	49	50
PROGRAM 6 Sequence	1	2	3	4	5	6	7	8	9	10
Save Group	51	52	53	54	55	56	57	58	59	60
PROGRAM 7 Sequence	1	2	3	4	5	6	7	8	9	10
Save Group	61	62	63	64	65	66	67	68	69	70
PROGRAM 8 Sequence	1	2	3	4	5	6	7	8	9	10
Save Group	71	72	73	74	75	76	77	78	79	80
PROGRAM 9 Sequence	1	2	3	4	5	6	7	8	9	10
Save Group	81	82	83	84	85	86	87	88	89	90
PROGRAM 10 Sequence	1	2	3	4	5	6	7	8	9	10
Save Group	91	92	93	94	95	96	97	98	99	100







Table 6.6 Save Table

The following is a step-by-step tutorial on how to set up a test file

1. Power on the electronic load. Self-test
2. Select the channel you want to edit and then edit every group's step. For this example, we will select channel 3 and channel 5 below. Press the   keys to switch channel to 3.
3. Press the  key to enter the channel setup menu.

4. Press the  key to enter the **Mode** menu.
5. Press the  key to select the operating mode. Every step's mode can be edited. Press the  key to confirm.
6. Press the  key to select **ISet**.
7. Press the  to enter the menu and set the working current. For example, to set 1A, press the  and then  to confirm.
8. Press the  key to move the cursor to $V_{max}=82.000V$ and press the  to set the upper limit of testing voltage. In this example, the first step is 5.8V.
 - Press the   and then  to confirm.
9. Press the  key to move the cursor to $V_{min}=0.000V$ and press the  to set the lower limit of testing voltage. In this example, the first step is 0.15V.
 - Press the    and then  to confirm.
10. After editing the first step of channel 3, press the  key to exit the menu.
11. Press the   keys to select channel 5. To edit the first step of channel 5, repeat steps 3 through 6 with desired parameters.
12. After editing the first step of channel 5, press the  key to exit the menu.
13. Save the edited first step of channel 3 and channel 5.
 - Press the  and  to save step 1.
 - Press the  to confirm.
14. In the same manner, edit the rest of the steps for channel 3 and channel 5 by repeating steps 2 through 10 above.

These saved groups correspond to sequences that will be selected in your program below.
15. Press the  +  key to enter the **Program** menu.
16. Press the  key to select **Edit Program** and press the  key.

17. The MDL4U Series with mainframe extension can support a maximum of 16 channels. 0 represents the MDL4U001 mainframe and 1 represents the MDL4U002 mainframe extension. 7531 indicates channels 1, 3, 5, and 7 have been equipped with electronic load modules.
18. Select the channels to be tested.
- For instance, to select channels 3 and 5, press the number keys 3 and 5. 'Y' denotes the channel is selected.
 - To cancel a channel, press the the number key again to cancel.
 - Then press the  to confirm your selection.
19. Select the steps needed to test.
- For example, to test 4 steps, press the 1 2 3 4 (0 stands for the tenth step).
 - To cancel a step, press the the number key again to cancel.
 - Press the  to confirm your selection.
20. To suspend a step, press the the number key of the step.
- For example, to suspend step 2, press the 2. Press the the number key again to cancel.
 - Then press the  to confirm your selection.
21. To edit the first step of the 4 steps, determine whether a short circuit testing on channel 3 and 5 is needed.
- For example, if channel 3 needs short circuit testing, input 3.
 - Then press the  to confirm your selection.
22. Set load on time (Ton).
- For example, if you need 2s, input 2 and then press the  key to confirm.
23. Set load off time (Toff).
- For example, if you need 2s, input 2 and then press the  key to confirm.
24. Set test delay time (Tpf).
- For example, if 1s is needed, input 1 and then press the  key to confirm.

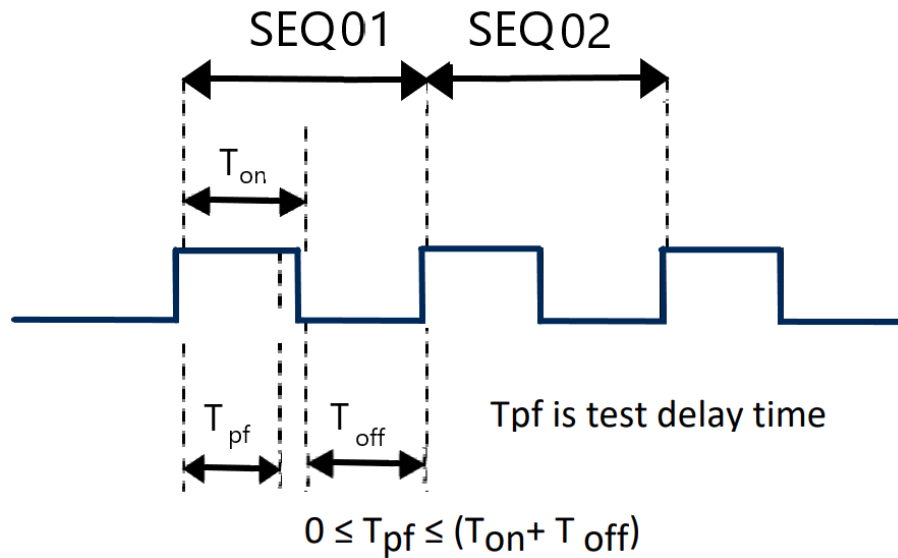

Figure 6.16 pf Delay Time

25. Repeat steps 17 through 20 and set the rest of the steps' load on/off time.

26. Set condition for when to stop testing.

- COMPLETE means to stop test when all steps are completed.
- FAILURE means to stop test when testing fails.
- Press the keys to select condition and press the to confirm.

27. Program chain is used when you need to link to the next file to be tested.

- For example, to link to group 2, press the 2.
- If no other file needs to be linked, input and then press the key to confirm.











28. Save the edited files into the EEPROM. Up to 10 program files can be saved.

- For instance, press the 1 to save the edited file to program file 1 and then press the to confirm.

29. Press the key to exit menu.

6.15.2 Recall Test Files

The following is a procedure on how to recall edited test files from the EEPROM:

1. Press  +  to enter the **Program** menu.
2. Press  key to select **Recall Prog** and press .
3. Input the saved program number and press  to recall the saved testing file.
4. To run the program, press  key to select **Run Program** and press .
5. Press  key to start automatic testing.
 - To pause, press  key and then press  key to continue.

6.16 Remote Operation

There are four types of communication interfaces available: **USB**, **Ethernet**, **GPiB**, and **RS232**.

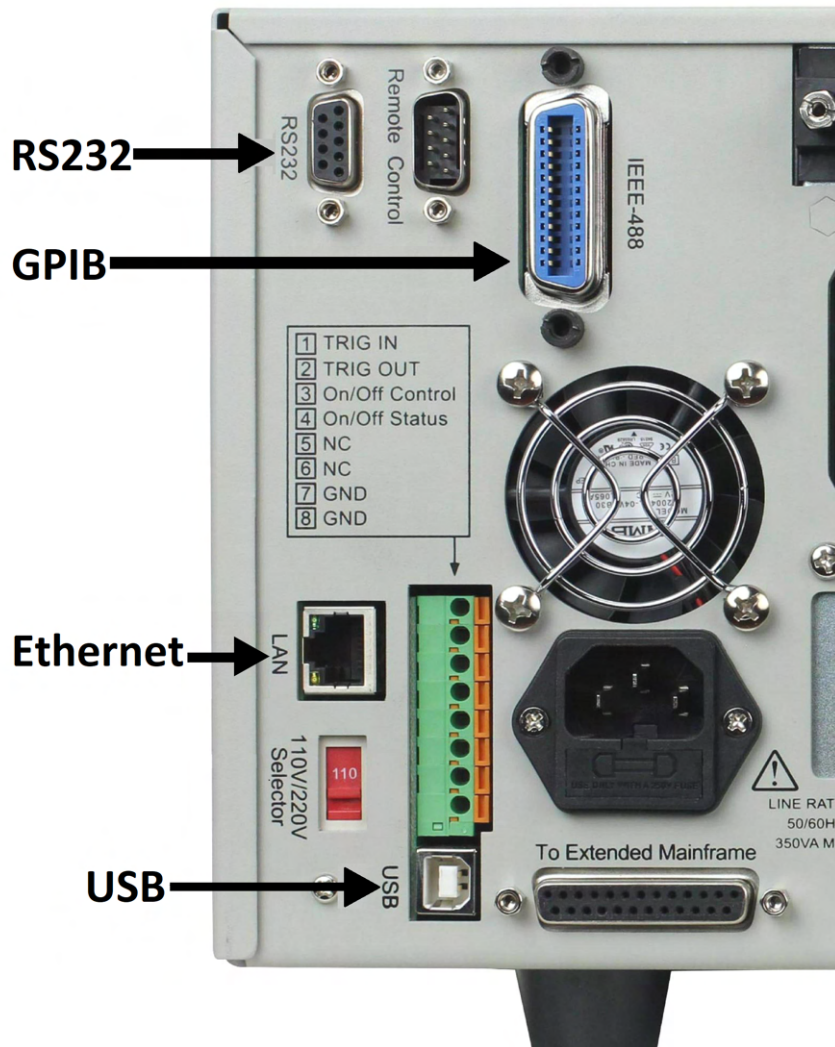



Figure 6.17 Communication Interfaces

6.16.1 USB Interface

Use Type A to Type B USB cables to connect the electronic load and the PC. All electronic load functions are programmable over the USB. Press  +  on the front panel to enter the **System** menu. Select **Communication** and choose **USBTMC-USB488**.



The USB488 interface capabilities of the electronic load are described below:

- The interface is IEEE 488.2 standard USB488 interface.
- The interface accepts REN_CONTROL, GO_TO_LOCAL, and LOCAL_LOCKOUT requests.
- The interface accepts MsgID = TRIGGER USBTMC command message and forwards TRIGGER requests to the function layer.





The USB488 device capabilities of the electronic load are described below:

- The device understands all mandatory SCPI commands.
- The device is SR1 capable.
- The device is RL1 capable.
- The device is DT1 capable.

6.16.2 Ethernet Interface

Use a network cable to connect PC through Ethernet interface of the electronic load. Press  +  on the front panel to enter the System menu. Select **Communication** and choose **ETHERNET**. Then select **Ethernet Set** to set gateway address **Gateway Set**, IP address **IP Set**, mask address **Mask set**, and port **port set**.

6.16.3 GPIB Interface

First connect GPIB port of electronic load to GPIB card of PC. There must be sufficient contact. Tighten the screws and then set the address. The address can be set from 0 to 31. Press  +  key to enter the **System** menu. Select **Communication** and choose **GPIB**. The electronic load operates from a GPIB address set from the front panel. To set the GPIB address, press  key to select **GPIB Address**. Input the address and press  key to confirm. The GPIB address is stored in non-volatile memory.

RS232 Interface



Use a cable with two COM interfaces (DB9) to connect the electronic load and PC. It can be activated by selecting **RS-232** in **Communication** of the **System** menu.

NOTICE

There are two COM interfaces on the rear panel of the MDL4U001 mainframe: the left 9-pin COM interface is the RS-232 communication interface and the right 9-pin COM serial port connection is not for use.

All SCPI commands are available through RS-232 programming. The EIA RS-232 standard defines the interconnections between data terminal equipment (DTE) and data communications equipment (DCE). The electronic load is designed to be a DTE and can be connected to another DTE such as a PC COM port through a null modem cable.



NOTICE

The RS-232 settings in your program must match the settings specified in the front panel System menu. Press  +  on the front panel to enter the **System** menu if you need to change the settings.

RS232 Data Format

The RS-232 data is a 10-bit word with one start bit and one stop bit.

The number of start and stop bits are not programmable. However, the following parameters are selectable in the System menu using the front panel  +  key.

Baud Rate

The System menu lets you select one of the following baud rates, which are stored in non-volatile memory: 4800, 9600, 19200, 38400, 57600, or 115200.

Parity

None - eight data bits without parity

Even - seven data bits with even parity

Odd - seven data bits with odd parity

RS232 Flow Control

The RS232 interface supports the following flow control options. For each case, the electronic load will send a maximum of five characters after hold-off is asserted by the controller. The electronic load is capable of receiving as many as fifteen additional characters after it asserts hold-off.

- **CTS/RTS:** The electronic load asserts its Request to Send (RTS) line to signal hold-off when its input buffer is almost full, and it interprets its Clear to Send (CTS) line as a hold-off signal from the controller.
- **XON/XOFF:** When the input queue of the electronic load becomes more than $\frac{3}{4}$ full, the instrument issues an X-OFF command. The control program should respond to this and stop sending characters until the electronic load issues the X-ON, which it will do once its input buffer has dropped below half-full. The electronic load recognizes X_ON and X_OFF sent from the controller. An X-OFF will cause the electronic load to stop outputting characters until it sees an X-ON.
- **NONE:** No flow control.

Flow control options are stored in non-volatile memory.

RS232 Connections

The RS-232 serial port can be connected to the serial port of a controller (i.e., personal computer) using a straight-through RS-232 cable terminated with DB-9 connectors. Do not use a null modem cable. Figure 33 shows the pinout for the connector.

If your computer uses a DB-25 connector for the RS-232 interface, you will need a cable or adapter with a DB-25 connector on one end and a DB-9 connector on the other. It must be a straightthrough (not null modem) a cable.

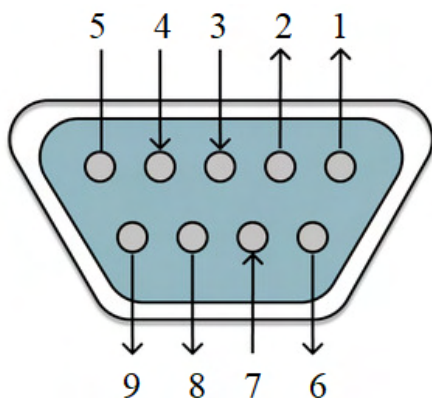

Figure 6.18 DB9 Pinout

Pin Number	Signal	Function
1	NC	No Connection
2	TXD	Transmit Data
3	RXD	Receive Data
4	NC	No Connection
5	GND	Ground
6	NC	No Connection
7	CTS	Clear to Send
8	RTS	Ready to Send
9	NC	No Connection

Table 6.7 DB9 Pinout

RS232 Troubleshooting

If you are having trouble communicating over the RS-232 interface, check the following:

- The computer and the electronic load must be configured for the same baud rate, parity, number of data bits, and flow control options. Note that the electronic load is configured for 1 start bit and 1 stop bit (these values are fixed).
- The correct interface cables or adapters must be used, as described under the RS-232 connector. Note that even if the cable has the proper connectors for your system, the internal wiring may be incorrect.
- The interface cable must be connected to the correct serial port on your computer (COM1, COM2, etc.) and the correct 9-pin serial port on the mainframe.

Communication Settings

Before communicating, please make sure that the following parameters of the electronic load match that of the PC. You can enter the System menu (Shift +) to make any changes.

Baud rate : 9600 (5800, 9600, 19200, 38400, 57600, 115200)

Data bit : 8

Stop bit : 1

Parity : None (None, Even, Odd)

Local address : 0 (0 through 31, default setting is 0)

NOTICE

When communicating with a PC, you can only use one communication interface at a time.

Specifications

Specifications

Model	MDL4U200	MDL4U252	MDL4U302	MDL4U305	MDL4U400	MDL4U505	MDL4U600	
Input rating								
Input Voltage	0 to 80 V	0 to 80 V	0 to 80 V	0 to 500 V	0 to 80 V	0 to 500 V	0 to 80 V	
Input Current	Low	0 to 4 A	0 to 3 A	0 to 4.5 A	0 to 3 A	0 to 6 A	0 to 3 A	0 to 12 A
	High	0 to 40 A	0 to 20 A	0 to 45 A	0 to 20 A	0 to 60 A	0 to 30 A	0 to 120 A
Input Power	200 W	250 W / 50 W ⁽¹⁾	300 W / 300 W ⁽¹⁾	300 W	400 W	500 W	600 W	
Channels	1	2	2	1	1	1	1	
Minimum Operating Voltage	Low	0.10 V at 4 A	0.15 V at 3 A	0.14 V at 4.5 A	0.7 V at 3 A	0.15 V at 6 A	0.54 V at 3 A	0.18 V at 12 A
	High	1 V at 40 A	1 V at 20 A	1.4 V at 45 A	4.5 V at 20 A	1.5 V at 60 A	5.4 V at 30 A	1.8 V at 120 A
CV mode								
Range	Low	0.1 to 18 V						
	High	0.1 to 80 V		0.1 to 500 V	0.1 to 80 V	0.1 to 500 V	0.1 to 80 V	
Resolution	Low	1 mV						
	High	10 mV						
Accuracy	Low	± (0.05% + 0.02% F.S.)		± (0.05% + 0.025% F.S.)	± (0.05% + 0.02% F.S.)			
	High	± (0.05% + 0.025% F.S.)						
CC mode								
Range	Low	0 to 4 A	0 to 3 A	0 to 4.5 A	0 to 3 A	0 to 6 A	0 to 3 A	0 to 12 A
	High	0 to 40 A	0 to 20 A	0 to 45 A	0 to 20 A	0 to 60 A	0 to 30 A	0 to 120 A
Resolution	Low	0.1 mA				1 mA	0.1 mA	
	High	1 mA				10 mA	1 mA	
Accuracy	Low	± (0.05% + 0.05% F.S.)						± (0.05% + 0.1% F.S.)
	High	± (0.05% + 0.05% F.S.)						± (0.1% + 0.1% F.S.)
CR mode								
Range	Low	0.05 Ω to 10 Ω		0.25 Ω to 10 Ω	0.05 Ω to 10 Ω	0.2 Ω to 10 Ω		
	High	10 Ω to 7.5 kΩ						
Resolution	16-bit							
Accuracy	Low	0.01% + 0.08 S						
	High	0.01% + 0.0008 S						
CW mode								
Range	200 W	250 W	300 W	400 W	500 W	600 W		
Resolution	10 mW							
Accuracy	± (0.2% + 0.2% F.S.)							
Transient mode (CC mode)								
TI&T2 ⁽²⁾	20 μs to 3600 s / Res: 5 μs to 10 ms							
Accuracy	5 μs + 100 ppm							
Slew Rate ⁽³⁾	Low	0.0001 to 0.25 A/μs	0.0001 to 0.2 A/μs	0.0001 to 0.25 A/μs	0.0001 to 0.1 A/μs	0.0001 to 0.25 A/μs	0.0001 to 0.1 A/μs	0.0001 to 0.25 A/μs
	High	0.001 to 2.5 A/μs	0.001 to 2 A/μs	0.001 to 2.5 A/μs	0.001 to 1 A/μs	0.001 to 2.5 A/μs	0.001 to 1 A/μs	0.001 to 2.5 A/μs

(1) MDL4U252: The user can allocate 250 W to either channel up to 300 W total (e.g. 50 W/250 W, 250 W/50 W, 150 W/150 W). MDL4U302: The user can allocate 300 W to either channel up to 600 W total (e.g. 300 W/300 W).

(2) Fast pulse trains with large transitions may not be achievable.

(3) The slew rate specifications are not warranted, but are descriptions of typical performance. The actual transition time is defined as the time for the input to change from 10% to 90%, or vice versa, of the programmed current values. In case of very large load changes, e.g. from no load to full load, the actual transition time will be larger than the expected time. The load will automatically adjust the slew rate to fit within the range (high or low) that is closest to the programmed value.

Specifications

Model	MDL4U200	MDL4U252	MDL4U302	MDL4U305	MDL4U400	MDL4U505	MDL4U600		
Readback voltage									
Range	Low	0 to 18 V							
	High	0 to 80 V		0 to 500 V		0 to 80 V		0 to 500 V	0 to 80 V
Resolution	Low	0.1 mV		1 mV		0.1 mV		1 mV	0.1 mV
	High	1 mV		10 mV		1 mV		10 mV	1 mV
Accuracy	± (0.025% + 0.025% F.S.)								
Readback current									
Range	Low	0 to 4 A	0 to 3 A	0 to 4.5 A	0 to 3 A	0 to 6 A	0 to 3 A	0 to 12 A	
	High	0 to 40 A	0 to 20 A	0 to 45 A	0 to 20 A	0 to 60 A	0 to 30 A	0 to 120 A	
Resolution	Low	0.01 mA				0.1 mA		0.01 mA	0.1 mA
	High	0.1 mA				1 mA		0.1 mA	1 mA
Accuracy	Low	± (0.05% + 0.05% F.S.)							± (0.05% + 0.1% F.S.)
	High	± (0.05% + 0.05% F.S.)							± (0.1% + 0.1% F.S.)
Readback power									
Range	200 W	250 W	300 W		400 W	500 W	600 W		
Resolution	10 mW								
Accuracy	± (0.2% + 0.2% F.S.)								
Protection range (typical)									
OPP	200 W	250 W	310 W	300 W	400 W	500 W	600 W		
OCP	Low	4.4 A	3.3 A	5 A	3.3 A	6.6 A	3.3 A	13.2 A	
	High	44 A	22 A	50 A	22 A	66 A	33 A	132 A	
OVP	82 V			510 V	82 V	510 V	82 V		
OTP	185 °F (85 °C)								
General (typical)									
Short Circuit									
Current (CC)	Low	4 A	3 A	5 A	3 A	6 A	3 A	12 A	
	High	40 A	30 A	50 A	20 A	60 A	30 A	120 A	
Voltage (CV)	0 V								
Resistance (CR)	25 mΩ	50 mΩ	30 mΩ	220 mΩ	25 mΩ	180 mΩ	15 mΩ		
Input Terminal Impedance	300 kΩ			1 MΩ		300 kΩ		1 MΩ	300 kΩ
Safety	EN61010-1:2010, EU Low Voltage Directive (LVD) 2014/35/EU								
Electromagnetic Compatibility	Meets EMC Directive 2014/30/EU, EN61326-1:2013								
Warranty	3 Years								
Dimensions	3.2" x 6.7" x 22.6" (82 x 170.5 x 573 mm)								
Weight	11 lbs (5 kg)								

Mainframe Specification

Number of Slots	Power Input	Operating Temperature	Storage Temperature	Humidity
4	110/220 V ± 10%, 50/60 Hz	32 to 104 °F (0 to 40 °C)	14 to 140 °F (-10 to 60 °C)	Indoor use, ≤ 95%

Note: Applies to MDL4U001 mainframe and MDL4U002 mainframe extension.

Specifications

Model	MDL4U102B	MDL4U200B	MDL4U252B	MDL4U302B	MDL4U305B	MDL4U400B	MDL4U502B	MDL4U505B	MDL4U600	
Input rating										
Input Voltage	0.1 to 80 V	0 to 80 V	0 to 80 V	0 to 80 V	0 to 600 V	0 to 80 V	0.1 to 600 V	0 to 600 V	0 to 80 V	
Input Current	Low	0 to 3 A	0 to 4 A	0 to 3 A	0 to 4.5 A	0 to 3 A	0 to 6 A	0 to 3 A	0 to 12 A	
	High	0 to 20 A	0 to 40 A	0 to 20 A	0 to 45 A	0 to 20 A	0 to 60 A	0 to 15 A	0 to 120 A	
Input Power	150 W / 50 W ⁽¹⁾	200 W	250 W / 50 W ⁽¹⁾	300 W / 300 W ⁽¹⁾	300 W	400 W	250 W / 50 W ⁽¹⁾	500 W	600 W	
Channels	2	1	2	2	1	1	2	1	1	
Minimum Operating Voltage	Low	0.09 V at 3 A	0.10 V at 4 A	0.15 V at 3 A	0.14 V at 4.5 A	0.7 V at 3 A	0.15 V at 6 A	0.6 V at 3 A	0.54 V at 3 A	0.18 V at 12 A
	High	0.6 V at 20 A	1 V at 40 A	1 V at 20 A	1.4 V at 45 A	4.5 V at 20 A	1.5 V at 60 A	3 V at 15 A	5.4 V at 30 A	1.8 V at 120 A
CV mode										
Range	Low	0.1 to 18 V					0.1 to 60 V	0.1 to 18 V		
	High	0.1 to 80 V			0.1 to 600 V	0.1 to 80 V	0.1 to 600 V		0.1 to 80 V	
Resolution	Low	1 mV								
	High	10 mV								
Accuracy	Low	± (0.025% + 0.025% F.S.)	± (0.05% + 0.02% F.S.)	± (0.05% + 0.025% F.S.)	± (0.05% + 0.02% F.S.)	± (0.025% + 0.025% F.S.)	± (0.05% + 0.02% F.S.)			
	High	± (0.025% + 0.025% F.S.)	± (0.05% + 0.025% F.S.)				± (0.025% + 0.025% F.S.)	± (0.05% + 0.025% F.S.)		
CC mode										
Range	Low	0 to 3 A	0 to 4 A	0 to 3 A	0 to 4.5 A	0 to 3 A	0 to 6 A	0 to 3 A	0 to 3 A	0 to 12 A
	High	0 to 20 A	0 to 40 A	0 to 20 A	0 to 45 A	0 to 20 A	0 to 60 A	0 to 15 A	0 to 30 A	0 to 120 A
Resolution	Low	0.1 mA						1 mA	0.1 mA	
	High	1 mA						10 mA	1 mA	
Accuracy	Low	± (0.05% + 0.05% F.S.)								± (0.05% + 0.1% F.S.)
	High	± (0.05% + 0.05% F.S.)								± (0.1% + 0.1% F.S.)
CR mode										
Range	Low	0.05 Ω to 10 Ω			0.25 Ω to 10 Ω	0.05 Ω to 10 Ω		0.2 Ω to 10 Ω		
	High	10 Ω to 7.5 kΩ								
Resolution	16-bit									
Accuracy	Low	0.01% + 0.08 S								
	High	0.01% + 0.0008 S								
CW mode										
Range	150 W	200 W	250 W	300 W		400 W	250 W	500 W	600 W	
Resolution	10 mW									
Accuracy	± (0.2% + 0.2% F.S.)									
Transient mode (CC mode)										
TI&T2 ⁽²⁾	20 μs to 3600 s / Res: 5 μs to 10 ms									
Accuracy	5 μs + 100 ppm									
Slew Rate ⁽³⁾	Low	0.0001 to 0.3 A/μs	0.0001 to 0.25 A/μs	0.0001 to 0.2 A/μs	0.0001 to 0.25 A/μs	0.0001 to 0.1 A/μs	0.0001 to 0.25 A/μs	0.0001 to 0.3 A/μs	0.0001 to 0.1 A/μs	0.0001 to 0.25 A/μs
	High	0.001 to 2 A/μs	0.001 to 2.5 A/μs	0.001 to 2 A/μs	0.001 to 2.5 A/μs	0.001 to 1 A/μs	0.001 to 2.5 A/μs	0.001 to 1.5 A/μs	0.001 to 1 A/μs	0.001 to 2.5 A/μs

(1) MDL4U252B: The user can allocate 250 W to either channel up to 300 W total (e.g. 50 W/250 W, 250 W/50 W, 150 W/150 W). MDL4U302B: The user can allocate 300 W to either channel up to 600 W total (e.g. 300 W/300 W).

(2) Fast pulse trains with large transitions may not be achievable.

(3) The slew rate specifications are not warranted, but are descriptions of typical performance. The actual transition time is defined as the time for the input to change from 10% to 90%, or vice versa, of the programmed current values. In case of very large load changes, e.g. from no load to full load, the actual transition time will be larger than the expected time. The load will automatically adjust the slew rate to fit within the range (high or low) that is closest to the programmed value.

Specifications

Model	MDL4U102B	MDL4U200B	MDL4U252B	MDL4U302B	MDL4U305B	MDL4U400B	MDL4U502B	MDL4U505B	MDL4U600B		
Readback Voltage											
Range	Low	0 to 18 V									
	High	0 to 80 V			0 to 600 V		0 to 80 V		0 to 600 V		0 to 80 V
Resolution	Low	0.1 mV			1 mV		0.1 mV		1 mV	0.1 mV	
	High	1 mV			10 mV		1 mV		10 mV	1 mV	
Accuracy	± (0.025% + 0.025% F.S.)										
Readback Current											
Range	Low	0 to 3 A	0 to 4 A	0 to 3 A	0 to 4.5 A	0 to 3 A	0 to 6 A	0 to 3 A			0 to 12 A
	High	0 to 20 A	0 to 40 A	0 to 20 A	0 to 45 A	0 to 20 A	0 to 60 A	0 to 20 A	0 to 30 A	0 to 120 A	
Resolution	Low	0.1 mA	0.01 mA				0.1 mA		0.01 mA	0.1 mA	
	High	1 mA	0.1 mA				1 mA		0.1 mA	1 mA	
Accuracy	Low	± (0.05% + 0.05% F.S.)									± (0.05% + 0.1% F.S.)
	High	± (0.05% + 0.05% F.S.)									± (0.1% + 0.1% F.S.)
Readback Power											
Range	150 W	200 W	250 W	300 W			400 W	250 W	500 W	600 W	
Resolution	10 mW										
Accuracy	± (0.2% + 0.2% F.S.)										
Protection Range (typical)											
OPP	165 W	200 W	250 W	310 W	300 W	400 W	275 W	500 W	600 W		
OCP	Low	3.3 A	4.4 A	3.3 A	5 A	3.3 A	6.6 A	3.3 A	3.3 A	13.2 A	
	High	22 A	44 A	22 A	50 A	22 A	66 A	16.5 A	33 A	132 A	
OVP	85 V	82 V			510 V	82 V	630 V		510 V	82 V	
OTP	185 °F (85 °C)						194 °F (90 °C)		185 °F (85 °C)		
General (typical)											
Short Circuit											
Current (CC)	Low	3 A	4 A	3 A	5 A	3 A	6 A	3 A	3 A	12 A	
	High	20 A	40 A	30 A	50 A	20 A	60 A	30 A			120 A
Voltage (CV)	0 V										
Resistance (CR)	50 mΩ	25 mΩ	50 mΩ	30 mΩ	220 mΩ	25 mΩ	50 mΩ	180 mΩ	15 mΩ		
Input Terminal Impedance	300 kΩ				1 MΩ		300 kΩ		1 MΩ	300 kΩ	
Safety	EN61010-1:2010+A1:2019, EU Low Voltage Directive (LVD) 2014/35/EU										
Electromagnetic Compatibility	Meets EMC Directive 2014/30/EU, EN61326-1:2013										
Warranty	3 Years										
Dimensions	3.2" x 6.7" x 22.6" (82 x 170.5 x 573 mm)										
Weight	11 lbs (5 kg)										

Mainframe Specification

Number of Slots	Power Input	Operating Temperature	Storage Temperature	Humidity
4	110/220 V ± 10%, 50/60 Hz	32 to 104 °F (0 to 40 °C)	14 to 140 °F (-10 to 60 °C)	Indoor use, ≤ 95%

Note: Applies to MDL4U001 mainframe and MDL4U002 mainframe extension.

Specifications

Mechanical Specifications

Model	MDL4U001	MDL4U002	MDL4U200	MDL4U252	MDL4U302	MDL4U305	MDL4U400	MDL4U505	MDL4U600
Type	Mainframe	Mainframe extension	Module						
Dimensions (W x H x D)	17.3" x 7" x 21.6" (440 x 177.3 x 549 mm)	17.3" x 7" x 21.6" (440 x 177.3 x 549 mm)	3.2" x 6.7" x 22.6" (82 x 170.5 x 573 mm)						
Weight	34 lbs (15.4 kg)	34 lbs (15.4 kg)	11 lbs (5 kg)						

Standard Accessories

Mainframes	Modules
Power cord, USB cable (MDL4U001 only), mainframe extension cable (MDL4U002 only)	Certificate of calibration

Service Information

Warranty Service: Please go to the support and service section on our website at bkprecision.com to obtain an RMA #. Return the product in the original packaging with proof of purchase to the address below. Clearly state on the RMA the performance problem and return any leads, probes, connectors and accessories that you are using with the device.

Non-Warranty Service: Please go to the support and service section on our website at bkprecision.com to obtain an RMA #. Return the product in the original packaging to the address below. Clearly state on the RMA the performance problem and return any leads, probes, connectors and accessories that you are using with the device. Customers not on an open account must include payment in the form of a money order or credit card. For the most current repair charges please refer to the service and support section on our website.

Return all merchandise to B&K Precision Corp. with prepaid shipping. The flat-rate repair charge for Non-Warranty Service does not include return shipping. Return shipping to locations in North America is included for Warranty Service. For overnight shipments and non-North American shipping fees please contact B&K Precision Corp.

Include with the returned instrument your complete return shipping address, contact name, phone number and description of problem.

B&K Precision Corp.
22820 Savi Ranch Parkway
Yorba Linda, CA 92887
bkprecision.com
714-921-9095

LIMITED THREE-YEAR WARRANTY

B&K Precision Corp. warrants to the original purchaser that its products and the component parts thereof, will be free from defects in workmanship and materials for a period of **three years** from date of purchase. B&K Precision Corp. will, without charge, repair or replace, at its option, defective product or component parts. Returned product must be accompanied by proof of the purchase date in the form of a sales receipt.

To help us better serve you, please complete the warranty registration for your new instrument via our website www.bkprecision.com

Exclusions: This warranty does not apply in the event of misuse or abuse of the product or as a result of unauthorized alterations or repairs. The warranty is void if the serial number is altered, defaced or removed.

B&K Precision Corp. shall not be liable for any consequential damages, including without limitation damages resulting from loss of use. Some states do not allow limitations of incidental or consequential damages. So the above limitation or exclusion may not apply to you.

This warranty gives you specific rights and you may have other rights, which vary from state-to-state.

B&K Precision Corp.
22820 Savi Ranch Parkway
Yorba Linda, CA 92887
www.bkprecision.com
714-921-9095

Version: January 29, 2025