

User manual

DAS1820

High Speed Modular Data Acquisition Recorder



Version V4.1.X

bkprecision.com - sefram.com

Sefram
a B&K Precision company

BK PRECISION

Chapter 1

Safety and symbols

To ensure proper use of the unit, please observe the safety and operating requirements described in this manual. Specific warning signals appear throughout this manual to draw your attention to important points. Please read the following instructions in this chapter carefully before using your Data Acquisition System. The table below describes the symbols used on the device.







Symbol	Description
	Warning
	Earth ground
	Chassis ground
	Earth terminal
	Direct current (DC)
	Alternating and direct current (AC and DC)
	Consult the user manual

Table 1.1: Symbols on the device

The table below describes the symbols used in this manual:



Symbol	Description
	Warning of a danger to the user
	Important operating information
	General tip

Table 1.2: Symbols in the manual



Before powering up the device :

- Read and understand the safety and operating information in this manual.
- Follow all listed safety precautions.
- Operating the instrument with the wrong supply voltage voids the warranty
- Use the appropriate earth protection when connecting live measurement input.
- Do not use the instrument in any way not specified in this manual or by SEFRAM. Failure to observe these precautions or warnings elsewhere in this manual constitutes a violation of the safety standards relating to the design, manufacture and intended use of the instrument. SEFRAM assumes no responsibility for any failure by the customer to comply with these requirements.

1.1 | Category rating

IEC 61010 defines safety categories that specify the amount of electrical energy available and the surges that can occur on the electrical conductors associated with these categories. The category index is a Roman numeral from I, II, III or IV. This classification is also accompanied by a maximum voltage, which defines the expected voltage pulses and required insulation distances. The categories are as follows :

- **Category I (CAT I)** : defines measuring instruments whose measurement inputs are not intended to be connected to the mains. Environmental voltages are generally derived from an energy-limited transformer or battery.
- **Category II (CAT II)** : defines measuring instruments whose measurement inputs are intended to be connected to the mains supply via a standard wall socket or similar sources. Examples include portable tools and household appliances.
- **Category III (CAT III)** : defines measuring instruments whose measurement inputs are intended to be connected to a building's electrical network. Examples include measurements inside a building's electrical panel, or the wiring of permanently installed motors.
- **Category IV (CAT IV)** : defines measuring instruments whose measurement inputs are intended to be connected to a building's primary power supply or other external wiring.



Do not use this instrument in an electrical environment with a higher category than that specified in this manual. You must ensure that each accessory used with this instrument has a category classification equal to or higher than that of the device to maintain the category classification of the instrument. Failure to do so will reduce the category classification of the measuring system.

1.2 | Power supply

This instrument is designed to be powered from a **CATEGORY II** main power supply environment. The main power supply must from 100 -240 VAC Use only the power cord supplied with the instrument, and make sure it is suitable for your country of use.



If smoke is produced when the unit is switched on, unplug the power cord from the mains socket and any cables connected to the unit, and contact B&K Precision or Sefram Technical Service.

1.3 | Ground the instrument



To minimize the risk of electric shock, the chassis of the instrument must be connected to a safety ground. The instrument is earthed via the earth conductor of the supplied power cable, which must be plugged into an approved three-conductor electrical socket. The power plug and the power cable coupling plug comply with IEC safety standards. Do not tamper with or disable the ground connection. Without the safety ground connection, all accessible conductive parts (including control buttons) may cause electric shock. If the unit is battery-powered, you must connect the chassis to earth when using it. Failure to use an approved, properly earthed plug and the supplied power cable may result in injury or death.

1.4 | Do not operate instrument if damaged



If the instrument is damaged, appears to be damaged, or if any liquid, chemical or other material is found on or inside the instrument, remove the power cord from the instrument, remove the instrument from service, label it for further use and return it to SEFRAM for repair. Notify Sefram or B&K Precision of the nature of any contamination of the instrument.

1.5 | Clean the instrument only in accordance with the instructions

To avoid the risk of electric shock, do not allow water to run into the appliance. Clean the appliance following these instructions:

- Use soapy water to clean the front and rear plates.
- Do not use any petrol-, benzine- or alcohol-based products that could damage the screen printing.
- Wipe with a soft, lint-free cloth
- Use an antistatic product to clean the screen

1.6 | Servicing



The instrument housing must not be disassembled by operating personnel. Component replacements and internal adjustments must be carried out by qualified maintenance personnel trained in the risks involved when instrument covers and screen are removed.

Under certain conditions, even with the power cord removed, dangerous voltages may exist when covers are removed. To avoid injury, always unplug the power cord from the instrument, disconnect all other connections (measurement leads, computer interface cables, etc.), discharge all circuits and check that no dangerous voltages are present on conductors by using a voltage detection device in good working order before touching internal parts. Check that the voltage sensing device is working properly before and after measurements by testing with known voltage sources and by testing AC and DC voltages. Do not insert any objects into the ventilation or other openings of the instrument. In the event of a fault, dangerous voltages may be present at unexpected points in the circuits under test. Fuse replacement must be carried out by qualified service personnel trained in the instrument's fuse requirements and safe replacement procedures. Disconnect the instrument from the power line before replacing fuses.

Replace fuses only with new ones of the types, voltage ratings and current ratings specified in this manual or on

the back of the instrument. Failure to do so may result in damage to the instrument, a safety hazard or fire. Failure to do so will void the warranty. Do not substitute parts not approved by SEFRAM or modify this instrument. Return the instrument to Sefram or B&K Precision for service and repair to ensure that safety and performance characteristics are maintained.

1.7 | Operating environment

The instrument is designed for use in pollution degree 2 indoor environments. The operating temperature range is 0 to 40 degrees Celsius and a relative humidity of 20% to 80%, non-condensing at an altitude < 2000 meters. Measurements taken with this instrument may be out of specification if the instrument is used in environments that may include rapid changes in temperature or humidity, sunlight, mechanical vibration and/or shock, acoustic noise, electrical noise, strong electric fields or strong magnetic fields.



- Do not use in explosive or flammable environments (ATEX).
- Do not use the instrument in the presence of flammable gases or vapors, fumes or fine particles.
- In relative humidity conditions outside instrument specifications.
- In environments where there is a risk of liquid spillage onto the instrument, or where liquid may condense on the instrument.
- In air temperatures exceeding specified operating temperatures.
- In atmospheric pressures outside specified altitude limits, or where the surrounding gas is not air.
- In environments with restricted cooling air flow, even if air temperatures are within specifications.
- In direct sunlight.

1.8 | Particular precautions



To avoid electric shock, observe the following precautions when working with dangerous voltages:

- Do not use this product for purposes other than those for which it is intended.
- Before using the recording device, make sure that the instrument and the equipment required for its use (measuring lead, external box, accessories...) are in working order. Check cables for damage.
- The instrument may only be used within the specified measuring ranges.
- The instrument may only be used in the measurement circuit category for which it has been designed.
- The instrument complies with EMC EN 61326. Otherwise, in rare cases, it may happen that an electrical device is disturbed by the electrical field of the instrument, or that the instrument is disturbed by an electrical device.
- The instrument may only be operated by qualified personnel.
- The test leads used to connect the instrument to the test points must comply with the standard.
- To avoid the risk of shock, do not connect or disconnect measuring leads when they are connected to a source of electrical voltage.
- Safety is no longer guaranteed if the instrument is modified or tampered with.
- Do not place heavy objects on the instrument.
- Do not block the flow of cooling air to the instrument.
- Do not place a hot soldering iron on the instrument.
- Do not pull on the instrument with the power cord or measuring leads connected.
- Place the device to allow a fast unplug of the main power cord



Safety is not guaranteed in these cases, for example :

- Damage to the instrument
- After dropping the instrument
- Instrument measurements/tests that cannot be performed
- Unfavorable conditions over an extended period
- Damage during transport
- Battery leak
- If the equipment is used in a manner not specified by this manual.

1.9 | Concerning the exported devices in North America



This equipment has been tested and found to comply with the limits for a Class A digital device, pursuant to part 15 of the FCC Rules. These limits are designed to provide reasonable protection against harmful interference when the equipment is operated in a commercial environment. This equipment generates, uses, and can radiate radio frequency energy and, if not installed and used in accordance with the instruction manual, may cause harmful interference to radio communications. Operation of this equipment in a residential area is likely to cause harmful interference in which case the user will be required to correct the interference at his own expense. Changes or modifications not expressly approved by SEFRAM or B&K Precision could void the user's authority to operate the equipment.

Contents

1	Safety and symbols	2
1.1	Category rating	3
1.2	Power supply	3
1.3	Ground the instrument	4
1.4	Do not operate instrument if damaged	4
1.5	Clean the instrument only in accordance with the instructions	4
1.6	Servicing	4
1.7	Operating environment	5
1.8	Particular precautions	6
1.9	Concerning the exported devices in North America	7
2	Introducing the device	16
2.1	Introduction	16
2.2	DAS1820 : Description	17
2.2.1	Overview	17
2.2.2	Interfaces	18
2.2.3	Factory option	19
2.3	Acquisition modules	20
2.4	Accessories	21
2.4.1	Supplied accessories	21
2.4.2	Optional accessories	21
2.5	Interface and ergonomic	22
2.5.1	Touch control	22
2.5.2	Sounds	22
2.6	Interface layout	22
2.6.1	Navigation	22
2.6.2	Status	22
2.6.3	Notifications	22
2.6.4	User fields	22
2.7	Built-in help	23
2.7.1	Tool type	23
2.7.2	Help window	23
2.7.3	On-board user manual	23
2.7.4	Help video	23
2.7.5	Step-by-step guides	23
3	Getting started	24
3.1	Installing and removing acquisition modules	24
3.2	File creation	25
3.3	Channels and measurements	26
3.4	Analog channel settings	26
3.4.1	Channel configuration	28
3.4.2	Calcul measurements	29
3.5	Digital channels setting	36
3.6	Setting script channels	38
3.6.1	Simple operation	39
3.6.2	Function script	39
3.6.3	Operation	40
3.7	Recording measurements	41

3.7.1	Recording file configuration	41
3.7.2	Sampling frequency	44
3.8	Start and stop settings	46
3.8.1	Manual	46
3.8.2	Start and Stop at date	47
3.8.3	Signal trigger	47
3.8.4	Pre-trigger	50
3.8.5	Post-trigger	51
3.8.6	Rearm	52
3.9	Setting save	53
3.10	External sync	54
4	Measurement data display	56
4.1	Real-time display	56
4.1.1	F(t) : Oscilloscope	57
4.1.2	DMM display	58
4.1.3	Custom display	59
4.2	Visualization and graphical analysis	61
4.3	Mathematical calculations	64
4.3.1	Definitions	64
4.3.2	Type of calculation	65
4.4	Analyzing a Record	68
4.5	Event marker	69
4.5.1	Using markers	69
4.5.2	Viewing markers in the file viewer	70
4.6	Exporting a record file	72
4.7	File transfer	75
4.7.1	File retrieval via USB key	75
4.7.2	File transfer via FTP protocol	75
4.7.3	File transfer via NAS	76
5	Advanced features	77
5.1	Units library	77
5.2	Sensors library	78
5.3	Sensor configuration	79
5.3.1	Creation of a new sensor	79
5.3.2	Configuration of a sensor with function : Linear	80
5.3.3	Configuration of a sensor with function : Affine	80
5.4	The different types of digital filter	83
5.4.1	Low-pass filter	83
5.4.2	High pass	83
5.4.3	Bandpass	84
5.4.4	Tape cutter	84
5.4.5	Filter prototype	84
5.5	Cold welding compensation	91
5.6	Calibration	93
5.7	Remote control	94
5.7.1	Web server	94
5.7.2	FTP	94
5.7.3	VNC viewer®	95
5.7.4	Email	96
5.7.5	SCPI protocol	97
5.7.6	NAS	98
5.7.7	MODBUS	100

6	Processing & Analysis	101
6.1	Power analysis	101
6.1.1	General information	101
6.1.2	Presentation & Programming	104
6.1.3	Data recording	109
7	MDF4 file format	110
7.1	Format	110
7.2	Version and compliance with ASAM standard	110
7.3	Interoperability	110
7.4	Functionality	110
7.5	Example	111
8	System	112
8.1	General settings for man/machine interface	112
8.2	Time setting	112
8.2.1	Manual	112
8.2.2	NTP	112
8.2.3	Time zone	112
8.2.4	Synchronization option	112
8.3	Network settings	114
8.3.1	Ethernet	114
8.4	Version	117
8.4.1	Software update	117
8.5	User level	120
8.6	Licenses	121
8.7	Bug report	122
9	Procedure and Maintenance	123
9.1	Metrology - Calibration	123
9.2	Cold junction adjustment procedure	123
9.3	Zero adjustment procedure	125
9.4	Case study : Sensor Examples	126
9.4.1	Pressure Sensor Type 4 - 20mA with 50 Ohm Shunt	126
9.4.2	Capteur pression type 0 - 10 V	127
10	Technical specifications	128
11	Servicing	134
11.1	For users not based in America	134
11.1.1	Warranty	134
11.1.2	After-sales contact	135
11.1.3	In case of breakdown	135
11.1.4	Packaging	135
11.1.5	LCD Display Defects	136
11.2	For users based in America	137
11.2.1	Warranty	137
11.2.2	Packaging	138
11.2.3	After-sales contact	138
11.2.4	Elements of tactile acceptance	138
12	Annexes	139
12.1	Revisions	139
12.2	SCPI Protocol	139
12.2.1	Physical link	139
12.2.2	Command syntax	139
12.2.3	Command list	141

12.3 EU Declaration of conformity 145

List of Figures

2.1	General views	17
2.2	View from above	18
2.3	Back view interface	18
2.4	Battery LED	19
2.5	Acquisition modules	20
2.6	Supplied accessories	21
3.1	Add an acquisition module	24
3.2	File Manager	25
3.3	File creation	25
3.4	Analog channel : Settings	26
3.5	Measurement bargraph	27
3.6	Analog channel : Configuration page	28
3.7	Edge detection	29
3.8	Edge detection with hysteresis	30
3.9	Counter	30
3.10	Frequency/PWM	31
3.11	Derivative calculation with sine signal	33
3.12	Derivative calculation with sine signal and low-pass filter Butterworth	34
3.13	Digital input: channel table	36
3.14	Digital input: channel parameters	37
3.15	Digital input: copying logic input parameters	37
3.16	Script channel: table of channels	38
3.17	Script channel: configuration page	38
3.18	Simple operation	39
3.19	Function script	39
3.20	Enable simultaneous recordings	43
3.21	Setting recording frequencies	44
3.22	Setting the frequencies on simultaneous recordings	45
3.23	Triggers settings	46
3.24	Start at date	47
3.25	Trigger on level	47
3.26	Edge trigger	48
3.27	Windows trigger	49
3.28	Combination of conditions	50
3.29	Pre-trigger	50
3.30	Inhibit function	51
3.31	Post-trigger	51
3.32	Creation of a configuration file	53
3.33	External sync menu	54
3.34	Chronogram Start/Stop	55
3.35	Chronogram Trigger	55
4.1	Real-time data display	56
4.2	F(t) in oscilloscope mode	57
4.3	DMM display	58
4.4	Averaging period DMM	58
4.5	Adding an overlay on DMM	59
4.6	Dashboard personalization	59

4.7	Min and max settings for X and Y axes	61
4.8	Zooming in and out on X and Y axes	62
4.9	Graphic display parameters	62
4.10	Measurement function	64
4.11	Calculation settings	64
4.12	Saved file list	68
4.13	Event marker	69
4.14	Mark event in file	70
4.15	Event marker display management	70
4.16	Marker of another recording trigger	71
4.17	Marker table showing simultaneous recordings	71
4.18	Select file for export	72
4.19	Selecting data for export	72
4.20	Select export period	73
4.21	Resampling	74
4.22	Selection of format	74
4.23	Copy a file to a USB key	75
4.24	Copy a file to the NAS	76
5.1	Unit libraries	77
5.2	Creation of a "pound" unit	77
5.3	Sensors library table	78
5.4	Create sensor	79
5.5	Programming of the linear function	80
5.6	Programming of the Affine Function – Two-Point Method	81
5.7	Programming of the Affine function – function method	82
5.8	Butterworth low-pass filter: Bode diagram	85
5.9	Butterworth low-pass filter: Impulse and step response	85
5.10	Chebyshev low-pass filter: Bode diagram	86
5.11	Chebyshev low-pass filter: Impulse and step response	86
5.12	Bessel low-pass filter: Bode diagram	87
5.13	Bessel low-pass filter: Impulse and step response	87
5.14	Filter comparison: Bode diagram	88
5.15	Filter comparison: Impulse response and step response	88
5.16	Calibration	93
5.17	Web server	94
5.18	FTP configuration	94
5.19	VNC configuration	95
5.20	New VNC viewer® connection	95
5.21	Connection	95
5.22	Email configuration	96
5.23	SCPI User interface	97
5.24	NAS Configuration	98
5.25	Modbus configuration	100
6.1	Calculation interval	102
6.2	Power Analysis Networks	104
6.3	Network settings	104
6.4	Measurement selection	105
6.5	Overview of the power analysis screen	106
6.6	Widget Histogram	107
6.7	Option Widget	107
6.8	Widget diagram Fresnel	108
6.9	Option Widget	108
6.10	Configuration of network analysis recording frequencies	109
8.1	Time base synchronization mode	113

8.2	Time base synchronization status	113
8.3	Configuration Page	114
8.4	Enp2s0 Interface	115
8.5	Fixed IP address setting	115
8.6	Manual IP configuration of PC and the recorder	116
8.7	System Version Home page	117
8.8	Web update option	118
8.9	USB key option	118
8.10	Update pop-up	119
8.11	User Level	120
8.12	License management	121
8.13	Create a bug report	122
9.1	Run thermocouple cold junction calibration button	123
9.2	Connecting thermocouples and standard/calibrator	124
9.3	Adjustment settings	124
9.4	Run zero calibration button	125
9.5	Connecting universal inputs	125
9.6	Card selection	125
11.1	Display areas	136
11.2	Display areas	138

List of Tables

1.1	Symbols on the device	2
1.2	Symbols in the manual	2
2.1	Specifications	20
3.1	Integration time by frequency	32
3.2	Operator and keyword support script channel	40
12.1	SCPI request description	141
12.3	SCPI command description	142
12.5	SCPI command description	143
12.7	SCPI command description	144

Chapter 2**Introducing the device****2.1 | Introduction**

SEFRAM is pleased to present the DAS1800 system, a new-generation multi-channel data logger developed and manufactured in France. The DAS1800 allows you to record and analyze different types of electrical signals (sensors, relays, electrical networks, etc.), making it a tool suitable for many industrial applications : maintenance, research and development, and production.

Thanks to its modular configuration, it offers great versatility and can capture events with microsecond precision.

The system can accommodate up to 10 acquisition modules, each offering 4 or 8 analog channels depending on the model chosen.

2.2 | DAS1820 : Description

The DAS1820 is a compact and ergonomic device, designed for simple and practical use. Its adjustable handle facilitates safe transport and can also be used as a support to position the device at an angle, thus offering greater comfort of use.

2.2.1 Overview



FIGURE 2.1 : General views

2.2.2 Interfaces

The various device interfaces are shown in the following diagrams :

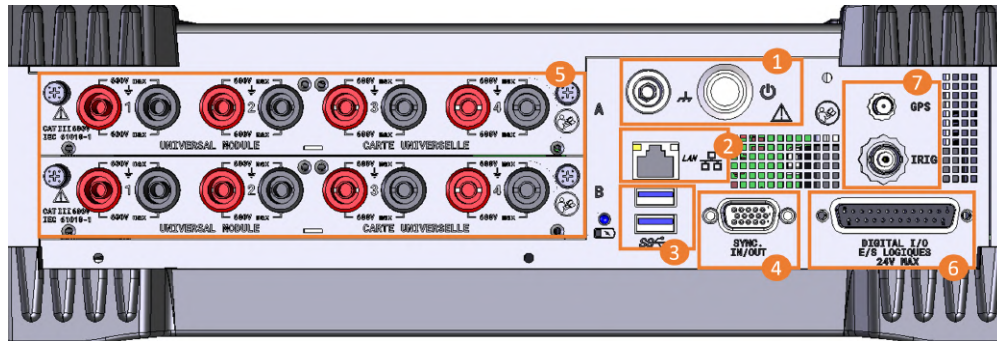

FIGURE 2.2 : View from above

Symbol	Description
(1)	On/off push-button and Chassis ground connector
(2)	Ethernet port for connecting the device to a computer network (see remote control section)
(3)	USB port for connecting mouse, keyboard, USB sticks or Wi-Fi (option) (x2)
(4)	Sub-D15 connector for external synchronization (See external synchronization section)
(5)	Acquisition boards
(6)	Sub-D25 connector for logical channel inputs and outputs
(7)	GPS / IRIG input connector (factory option)

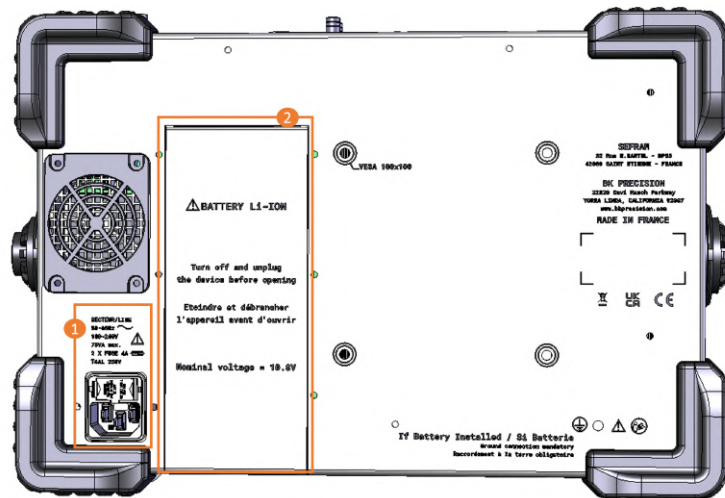

FIGURE 2.3 : Back view interface

Symbol	Description
(1)	AC power supply and fuse holder (2 × T4AL 250 V)
(2)	Battery compartment (factory option)

2.2.3 Factory option

Factory options are only available for the DAS1820 version.

- GPS/IRIG input : allows the instrument to be time-synchronized with a GPS/IRIG signal (available soon)
- Battery option : allows the instrument to work without power cord to a electrical grid

A battery charge status LED is present on the device.

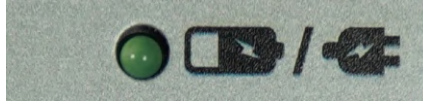

FIGURE 2.4 : Battery LED

Status	Description
Off	No battery connected or battery discharging
On continuously	Battery fully charged
Blinking at 0.5 Hz	The battery is charging
Blinking at 2.5 Hz	Battery error

2.3 | Acquisition modules

When you order the device, you can choose from four different types of modules: universal, multiplexed, high-voltage or high-impedance. Each has its own technical characteristics (see Chapter : [Technical specifications](#) for details).



Universal module

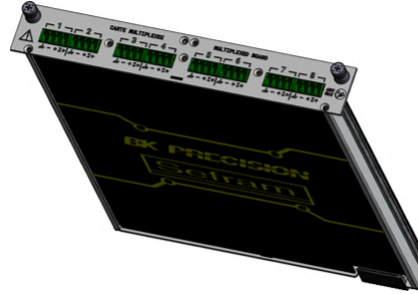

Multiplexed module

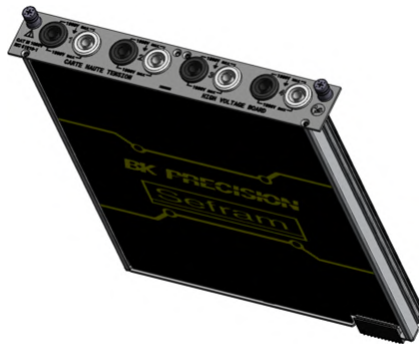

High voltage module



High impedance module

Figure 2.5: Acquisition modules

Specifications	Universal board	Multiplexed board	High voltage board	High impedance board
Number of channels	4 isolated single-pole channels	8 non-isolated differential channels	4 isolated differential channels	4 isolated single-pole channels
Maximum voltage	+/- 600V DC or 424V RMS	+/- 48V DC	+/- 1500V DC or 1000V RMS	+/- 600V DC or 424V RMS
Maximum sampling rate	1MSa/s	5Sa/s	1MSa/s	1MSa/s
Bandwith	100kHz	1kHz	100 kHz	70 kHz
Input impedance	1MOhms	2MOhms	10MOhms	10MOhms
Safety category	CAT III 600V	CAT I 48V	CAT III 1500V / CAT IV 1000V	CAT III 600V

Table 2.1: Specifications

2.4 | Accessories

2.4.1 Supplied accessories



Main power cord (IEC)



Carrying case



Sub-D15 HD connector (x1)



Sub-D25 connector (x1)



Pair of male banana plug connectors (x4) (for universal and high-impedance acquisition boards)



4-pin connector (x8) (with multiplexed board)

FIGURE 2.6 : Supplied accessories

2.4.2 Optional accessories

- Logic channel box 917008000 : allows logic inputs/outputs to be transferred to an external module, increasing the maximum permissible voltage.
- Logic channel cable 902407000 : allows inputs/outputs to be remotely connected to a standard banana plug cable
- Current shunts 50 Ohm D18-UZ50 : allows current measurement via voltage sensor for 4-pin input (multiplexed board)
- Current shunts 0.01 Ohm D18-UZ001 : allows current measurement via voltage sensor for 4-pin input (multiplexed board)
- Current shunt 250 Ohm D18-MZ250 : allows current measurement via voltage sensor for 4-pin input (multiplexed card)

2.5 | Interface and ergonomic

2.5.1 Touch control

The product is designed for smartphone-type touch screen use. The following movements are implemented :

- Single tap: performs an action
- Drag & drop: moves graphic objects
- 2-finger zoom
- Long press: displays a help tooltip

2.5.2 Sounds

Sound notifications indicate :

- Product startup
- Click for feedback
- Recording start and end

2.6 | Interface layout

2.6.1 Navigation

Navigation on the device used via the menu bars at the top of the page (main and secondary).

2.6.2 Status

The bar at the bottom indicates the device status:

- Registration status
- Error messages
- Date and time

2.6.3 Notifications

Notifications are classified into 2 levels of importance :

- High importance: a warning window opens in the center of the page. A user action is required to make it disappear. They are used for configuration or hardware errors.
- Low importance: a message bar appears at the top of the screen and disappears after a few seconds. It notifies the user of product events (end of recording, file saving, etc.).

2.6.4 User fields

The value of a user field is taken into account as soon as editing is complete. No further validation is required. When the value is incorrect, a red error message informs the user that the current value is invalid.

2.7 | Built-in help

2.7.1 Tool type

When you long-click on a button, a tooltip displays help on the corresponding action.

2.7.2 Help window

Clicking on the question mark icon opens a help window.

2.7.3 On-board user manual

The user manual is embedded in the product and available from any page by clicking on the manual button in the main menu bar at the top of the page.

2.7.4 Help video

Help videos are available from the "Home" page.

2.7.5 Step-by-step guides

Step-by-step guides are available on the "Home" page, to help you get the most out of your product.

Chapter 3

Getting started

3.1 | Installing and removing acquisition modules



Module installation and removal must be carried out with the power off. When doing so, switch off the device and ensure that no cables are connected to the module inputs.

Add an acquisition module: The module plugs into the device as a simple way. Simply follow the keyed connection (1) and guide the module to the backplane to connect to the connector (2). Press to ensure a good connection. Once connected, use a Phillips screwdriver to tighten the two screws on either side of the module (3).



Modules are detected at startup.



Figure 3.1: Add an acquisition module

Remove an acquisition module: To remove an acquisition module, loosen the two screws on either side of the board (3). Pull on the module to disconnect it.

3.2 | File creation

Before starting a measurement campaign, we recommend that you organize your files in advance. To do this, go to "File Manager" in the navigation bar :

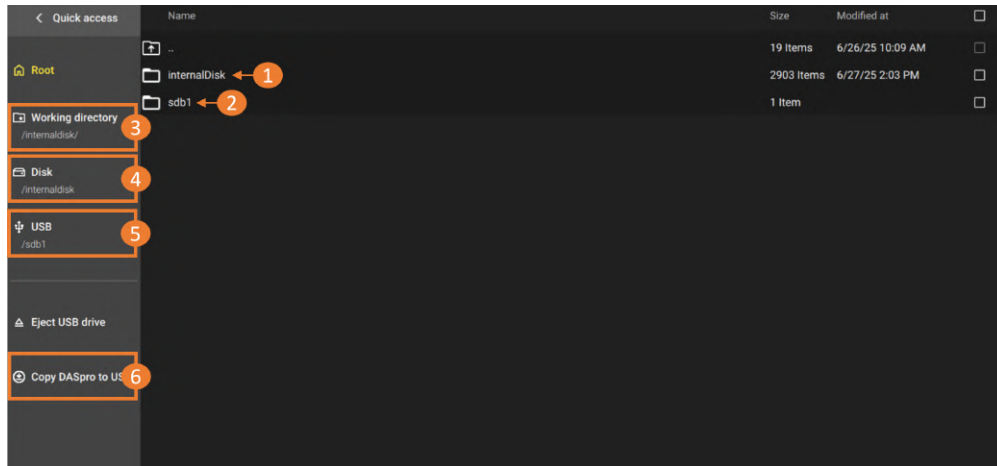

Figure 3.2: File Manager

"Internaldisk" (solid drive a1) (1) corresponds to the contents of the device's disk memory. It is also available by pressing "DISK" (4). If a USB stick is connected to the device, then a "sdb1" folder will be displayed, and will be available from this page. The contents of the USB stick are also available by pressing "USB" (5). You can also access the contents of the working directory (3). Finally, option (6) allows you to download the DASpro software directly to the inserted USB drive.

Working directory : In order to create a measurement campaign folder and define it as a working directory, go to the disk memory folder "internaldisk"



The working directory is the defined location where all files (measurement records, configuration files, screenshots, bug reports) will be saved. Several folders can be created, but only one folder can be defined as the working directory at a time. It is not possible to define a folder on a USB stick as a working directory. By default, files are placed at the root of the hard disk

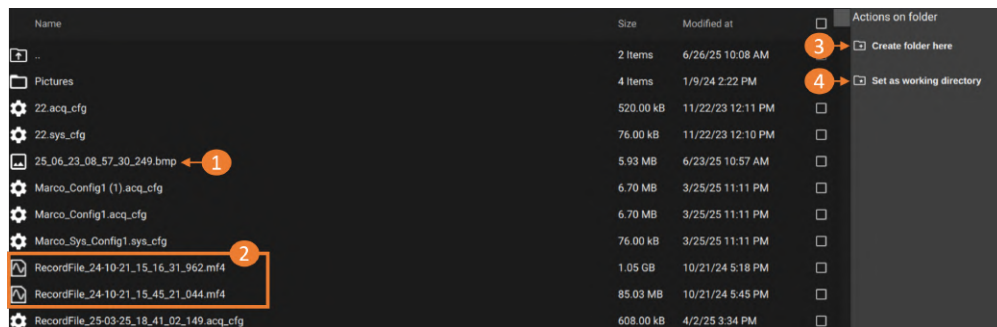

Figure 3.3: File creation

By default, screenshots (1) and measurement recordings (2) are at the root of the disk. Click on create a new folder, name and select it then click on "choose as working directory". Select "Create New Folder" (3), name it, and select "Set as Working Folder" (4).

3.3 | Channels and measurements

A channel corresponds to a physical input to the device. It is identified by its alias, which corresponds to its position on the instrument. For example, channel B1 corresponds to the channel number 1 on the acquisition module B (i.e. the second module).

A measurement is a direct input or calculation derived from a physical channel.

The type of measurement available depends on the property being measured and the configuration of the physical channel. For example it includes RMS, average, minimum, maximum, derivative and integral.

3.4 | Analog channel settings

To access acquisition module analog channel settings, use the main navigation bar by clicking on "Configuration" > "Channels".

Color	Position ↑	Name	Board	Sensor	Min	Max	Measurements	Configure
Yellow	A1	Ch_A1	Universal	No sensor	-500.0V	500.0V	Direct RMS	⚙️
Light Green	A2	Ch_A2	Universal	No sensor	-500.0V	500.0V	Direct RMS	⚙️
Green	A3	Ch_A3	Universal	No sensor	-500.0V	500.0V	Direct RMS	⚙️
Cyan	A4	Ch_A4	Universal	No sensor	-500.0V	500.0V	Direct RMS	⚙️
Yellow	B1	Ch_B1	Multiplexed	No sensor	-10.00V	10.00V	+	⚙️
Light Green	B2	Ch_B2	Multiplexed	No sensor	-10.00V	10.00V	+	⚙️
Green	B3	Ch_B3	Multiplexed	No sensor	-10.00V	10.00V	+	⚙️
Cyan	B4	Ch_B4	Multiplexed	No sensor	-10.00V	10.00V	+	⚙️
Blue	B5	Ch_B5	Multiplexed	No sensor	-10.00V	10.00V	+	⚙️
Dark Blue	B6	Ch_B6	Multiplexed	No sensor	-10.00V	10.00V	+	⚙️
Purple	B7	Ch_B7	Multiplexed	No sensor	-10.00V	10.00V	+	⚙️
Dark Purple	B8	Ch_B8	Multiplexed	No sensor	-10.00V	10.00V	+	⚙️

Figure 3.4: Analog channel : Settings

On this page you can view the table containing all the parameters of the analog channels. It is possible to filter the display of channels by acquisition card present on the device (1), and to customize the display of information given in columns (2). Single-channel parameters are displayed online (3). Most parameters can be edited from this table, allowing you to define all the settings required for your measurement. Let's take a look at channel C1:

- The *position* column corresponds to the physical location of the track on the map and in the device.
- The *name* column corresponds to the track name (editable).
- The *type* column corresponds to the type of acquisition card installed.
- The *sensor* column defines the physical parameter to be measured by the channel. The default value is voltage measurement. First define the unit, then the sensor.



By default, a choice of sensors is present in the sensor library. You can add new sensors as required by clicking on “Create a new sensor”. See section : [Sensors library](#) for more details.

The “Min” and “Max” columns frame the range measured by the channel. These parameters define the caliber used by the instrument, and consequently impact measurement accuracy. The function automatically centers the zero between the Min and Max terminals (editable).

Once validated, the measurements appear in the bar graph **(4)** on the left of the screen. It is possible, for example, to record both the direct voltage and the RMS value of the same signal.

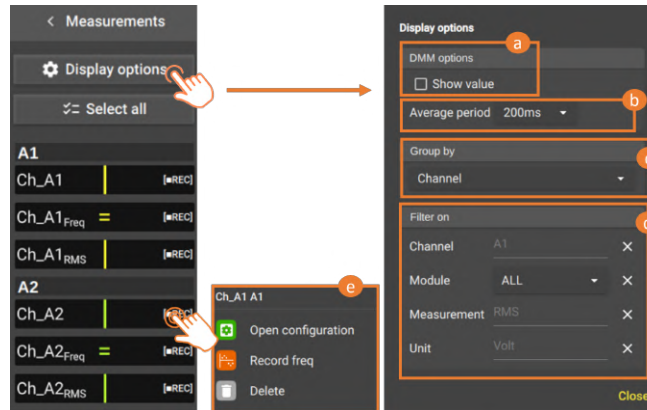



Figure 3.5: Measurement bargraph

Pressing the “Display option” button opens the bargraph display and filter configuration page. Here you’ll find several options:

- Activate DMM display directly in the bargraph **(a)**.
- Modify value update period **(b)**.
- Sort values **(c)** by channel, module, measurement or unit.
- Filter the displayed measurements in the bargraph **(d)**.

In addition, a long press on a measurement **(e)** allows you to delete it, access channel parameters or configure recording frequency.

3.4.1 Channel configuration

By pressing  in the “Configure” column, you open the complete page of channel parameters shown above.

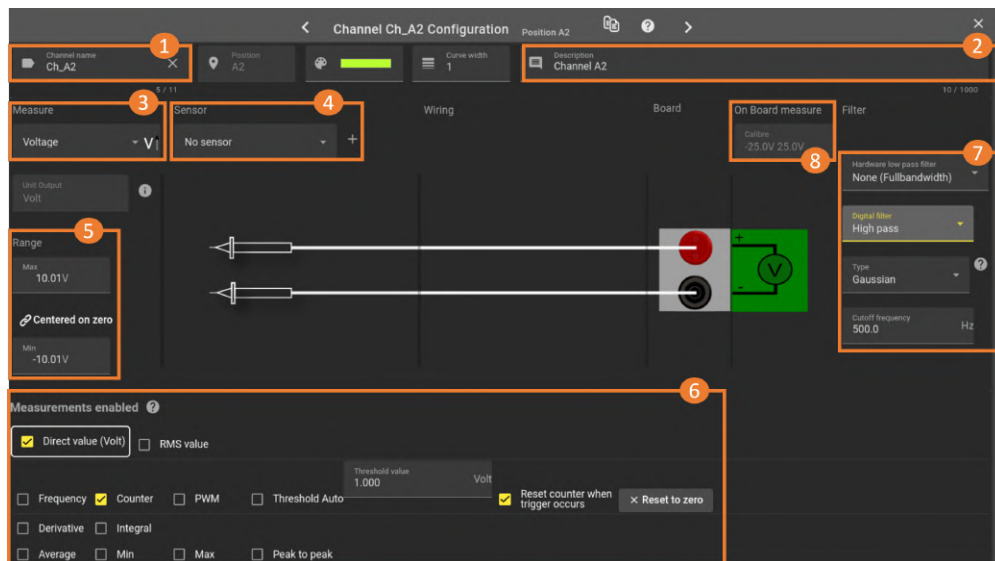

Figure 3.6: Analog channel : Configuration page

1. Channel name displayed on graphics, can be modified but limited to 11 characters.
2. Channel description, allows you to enter complete information about the channel.
3. Selection of the physical parameter measured by the channel.
4. Select the sensor to be used from an existing list. To add a sensor not present in the library, click on the "+" icon,
5. Calibration determines the range of values displayed on the screen. It differs from the actual measurement range of the sensor used. It is essential to choose a calibre that matches the actual range of measured values: as close as possible to the expected minimum and maximum values. The DAS system automatically adjusts the internal voltage rating according to the set rating. Incorrect calibration can affect the accuracy of displayed measurements. You can also define the zero position, i.e. whether or not the display is centered around a reference value (symmetry of the signal with respect to the minimum and maximum gauge values)



Example: For a pressure sensor with a measurement range of 0 to 300 bar, but whose actual use is limited to a range of 0 to 100 bar, it is advisable to adjust the gauge accordingly to optimize readability of the data on the display. In this case, you can configure :

- Minimum gauge value : 0 bar
- Maximum gauge value : 110 bar (slightly higher than the maximum expected value, to allow for a safety margin)

This setting improves display accuracy and facilitates data interpretation. If the measured value is outside these limits, it will not appear on the display.

6. Set the measurements of your channel to be displayed and/or recorded. Note that for frequency, counter and PWM measurements, you must set a detection threshold.

7. The drop-down menu lets you define a filter, ideal for attenuating/removing electronic noise induced by external disturbance elements on your measurement. See “How to attenuate noise on my signal” for more details. Total bandwidth depends on the type of frame grabber used. To apply a cutoff frequency before 100Hz, use the keyboard to define a digital filter (software processing). Alternatively, apply a hardware filter (signal input processing) from a choice of 100Hz, 1000Hz or 10,000Hz. See section : [Sensors library](#) for more details.
8. When a frequency measurement or operation in counter mode is selected, the range (5) is no longer displayed as adjustable. It is replaced by an automatic range indication, provided for informational purposes according to the measurement in progress. An example of use is presented in the section dedicated to use cases, particularly for sensor programming applications.



By pressing the icon shown below, you can duplicate all the parameters of the selected channel to other channels on the device.

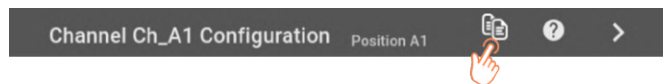

3.4.2 Calcul measurements

Signal edge detection

The frequency, PWM, RMS and counter measurements are calculated by detecting rising and falling signal edges. A rising edge occurs when the signal rises above the threshold value. A falling edge occurs when the signal falls below the threshold value. The figure below shows the rising and falling edges of the signal for a threshold value set at 0V. Signal samples are shown in green :

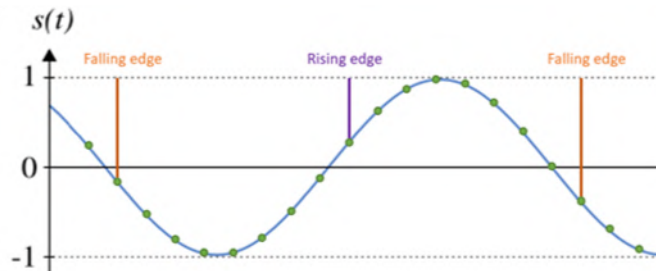

Figure 3.7: Edge detection

The signal noise can interfere with edge detection. The signal may pass above and below the threshold several times in succession. To correct this problem, edge detection uses a high and a low threshold. A rising edge is detected when a signal sample is measured above the high threshold. A falling edge is detected when a signal sample is measured below the low threshold. A rising edge is necessarily followed by a falling edge, and a falling edge is necessarily followed by a rising edge

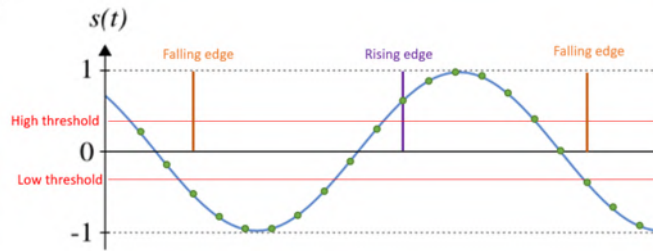

Figure 3.8: Edge detection with hysteresis

The difference between high and low threshold corresponds to $\pm 0.25\%$ of the rating used (e.g. 100V rating and threshold set to 0V, $V_{min} = -250$ mV and $V_{max} = 250$ mV).

The threshold value can be set directly by the user via the HMI. Simply uncheck the “Auto threshold” option and specify the threshold value in volts.

The threshold can also be calculated automatically. The minimum and maximum signal values are measured over a period of one second. We calculate the sliding average of these values obtained each second (sliding averages calculated over 10 values, i.e. 10 periods). We then calculate the mean value between the sliding averages of the most recent maximum and minimum values. If the difference between this value and the current threshold is greater than 1% of the caliber, the threshold is considered to need readjustment. We then wait for the signal to reach a stable value. To do this, the values of the sliding averages of the minimum and maximum signal values are stored in 2 FIFOs of 5 locations. If the difference between the sliding average of the most recent maximum value and the sliding average of the oldest maximum value is less than 1% of the caliber (identical for the sliding average of the minimum value), then the signal is considered to have reached a stable value, and the device updates the threshold with the previously calculated value (average between the most recent sliding average of the maximum value and the sliding average of the minimum value).

For high-frequency signals, the average calculated each second is virtually identical. The standard deviation is calculated on the last three averages calculated over a period of one second. If the standard deviation is less than 0.05% of the range, the signal is considered stabilized and the last average is assigned to the threshold. This method means that you do not have to wait for the rolling average to stabilize, and can therefore be more reactive.

Measurement counter

This measurement is used to count the number of trigger signals according to a manually or automatically defined threshold.

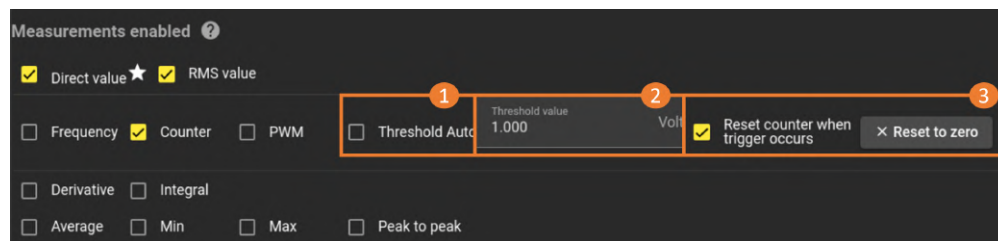

Figure 3.9: Counter

The trigger threshold can be set automatically (1). The device calculates it according to the signal, and updates it approximately every second. Or manually (2), by directly entering the value in Volt.

Reset to zero (3) can also be done automatically by checking the “Reset counter on trip” option, or manually with the “RESET TO ZERO” button.



Automatic threshold calculation is not recommended for this measurement. It is based on zero crossing detection so, if you consider a 0V signal with peaks (e.g. a TTL signal), the system will detect a rising edge at the first voltage peak and will wait for a falling edge. The signal then returns to 0V, but never below the low voltage threshold (negative voltage). The falling edge will never be detected.

Measurement Frequency/PWM

The frequency and the duty cycle of the signal are calculated by detecting the rising and falling edges of the signal relative to a threshold. The period of the signal corresponds to the time between two rising edges of the signal. The time in the high state corresponds to the time between a rising edge and a falling edge. The frequency of the signal corresponds to the inverse of the period. The duty cycle corresponds to the time spent in the high state divided by the signal period. In order to increase the accuracy of the measurement of the period and the time spent in the high state, the technique used here consists of linearizing the signal between two samples located on either side of the threshold. Since the sampling period is known, it is possible to approximate the time between the reception of the last sample before the threshold is crossed and the time corresponding to the crossing of the threshold (time to threshold), as well as the time between the crossing of the threshold and the reception of the sample located after the threshold is crossed (time from threshold).

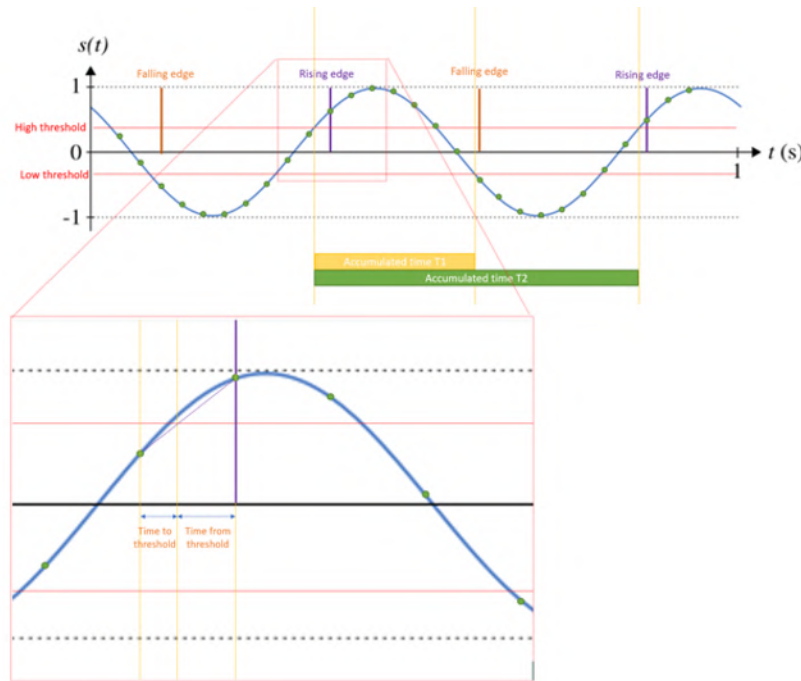

Figure 3.10: Frequency/PWM

For signals with frequencies less than or equal to 100Hz, we measure the time corresponding to one period. For signals with frequencies greater than 100Hz, several periods are measured in order to obtain an average period and thus limit the error:

Frequency (Hz)	Period (s)	No. of samples per period	No. of periods for calculation	No. of samples for calculation	Integration time
0.1	10.0000	10000000	1	10000000	10.00
0.2	5.0000	5000000	1	5000000	5.00
0.3	3.3333	3333333	1	3333333	3.33
0.4	2.5000	2500000	1	2500000	2.50
0.5	2.0000	2000000	1	2000000	2.00
0.6	1.6667	1666666	1	1666666	1.67
0.7	1.4286	1428571	1	1428571	1.43
0.8	1.2500	1250000	1	1250000	1.25
0.9	1.1111	1111111	1	1111111	1.11
1	1.0000	1000000	1	1000000	1.00
2	0.5000	500000	1	500000	0.50
10	0.1000	100000	1	100000	0.10
50	0.0200	20000	1	20000	0.02
100	0.0100	10000	1	10000	0.01
200	0.0050	5000	2	10000	0.01
300	0.0033	3333	3	9999	0.01
400	0.0025	2500	4	10000	0.01
500	0.0020	2000	5	10000	0.01
600	0.0017	1666	6	9996	0.01
700	0.0014	1428	7	9996	0.01
800	0.0013	1250	8	10000	0.01
900	0.0011	1111	9	9999	0.01
1000	0.0010	1000	10	10000	0.01

Table 3.1: Integration time by frequency

Measurement RMS

The TRMS value of a signal is given by the formula :

$$V_{TRMS} = \sqrt{\frac{1}{T} \cdot \int_{t_0}^{t_0+T} s^2(t) \cdot dt}$$

In other words, the RMS value of a signal is obtained by taking the squares of all the signal values, calculating their average, and then taking the square root of this average. As with the frequency and PWM measurements, calculations are performed over one or more signal periods. For very low-frequency or DC signals, the RMS value is updated when the accumulator is exceeded, enabling the squares of all values to be summed.

Measurement derivative

A numerical approximation of the derivative is obtained by calculating the slope between two points with coordinates (x_i, y_i) and (x_{i+1}, y_{i+1}) . The derivative is associated with the abscissa x_i .

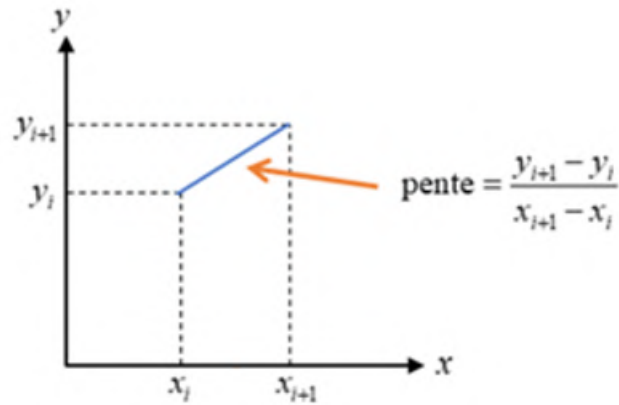

The time between two points used to calculate the derivative is given by the parameter Δ_t . The derivation of digital data is generally accompanied by a significant increase in measurement noise (the digital differentiation operation constitutes high-pass filtering). The figure below shows the calculation of the derivative of a sinusoidal signal of frequency 10 Hz with period $\Delta t = 1$ ms)

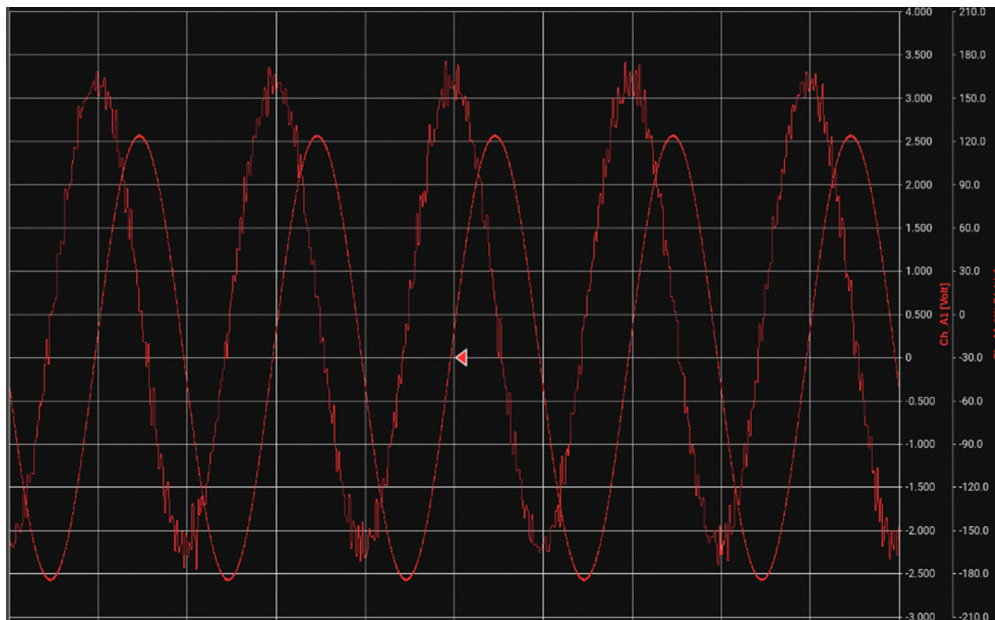

Figure 3.11: Derivative calculation with sine signal

One solution is to attenuate the noise present in the signal by applying a digital filter. The following figure shows the derivative of the same signal using a low-pass Butterworth digital filter (order 4) with cut-off frequency $F_0 = 1/(6\Delta_t) = 167\text{Hz}$.

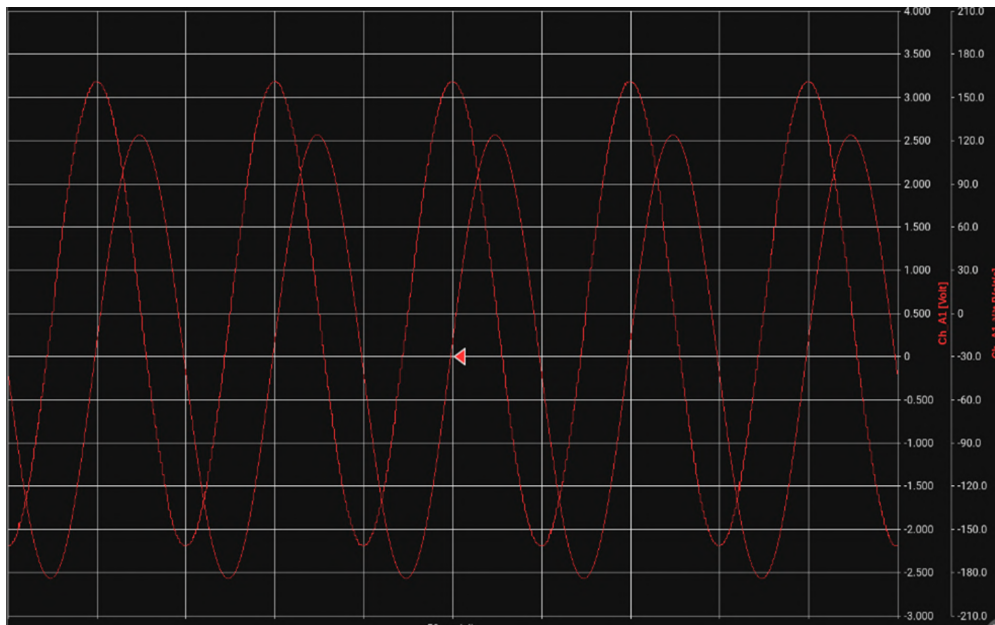

Figure 3.12: Derivative calculation with sine signal and low-pass filter Butterworth

The choice of F_0 depends on the effectiveness of noise rejection. If the signal to be processed is fairly "noisy", it is necessary to use high large values of T_0 (*i.e.* $T_0 \sim 30\Delta_t$). This has a number of disadvantages :

- Inability to derive rapidly changing signals
- Relative inaccuracy of derivative (long start-up transient, possible shift in maximum position, etc.).

On the other hand, if the signal is not very noisy, a high value of F_0 , which will mitigate the above disadvantages. However T_0 must always be greater than Δ_t , either $T_0 > 3$ or $4 \Delta_t$. The optimum value for T_0 is usually determined by successive trials.

Measurement integral

The signal is sampled at a frequency of 1 MHz, giving one sample every microsecond. The signal integral is obtained by accumulating the sample values ($V \cdot \mu s$). The integral value is obtained in V.s by dividing the accumulated value by the sampling frequency.

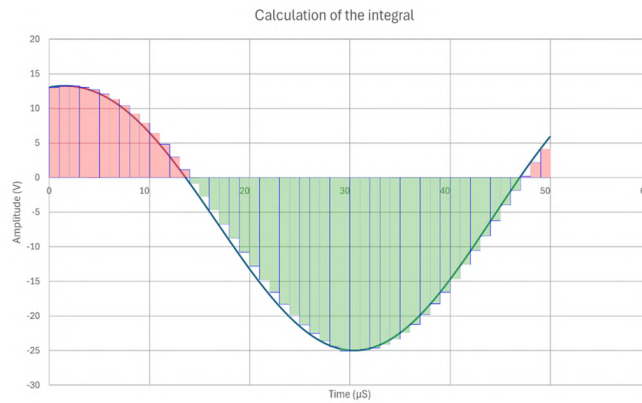

The accumulator value is reset to zero after pressing the "Reset integrate" button, or at the start of recording if the "Reset integrate on acquisition start" option is enabled. The accumulator value returns to zero if the maximum value is exceeded.



The value of the integral of the signal returned by a transducer can only be calculated if its conversion function is linear ($Out_{capt} = a \cdot V_{IN}$). The value of the integral cannot be calculated if the conversion function is affine ($Out_{capt} = a \cdot V_{IN} + b$). The y-intercept is not known.

3.5 | Digital channels setting

Digital channels are accessible via the device 25-pin D-Sub connector. To access digital channel settings, press “Configuration” > “Channels” > “Digital”.



The optional digital channel cable accessory allows all digital channels to be wired using standard banana plugs, giving you greater convenience when wiring your equipment.

Color	Position ↑	Name	Measurements	Configure	
Light Blue	1	Vlog1	Ch_Vlog1	Direct	⚙️
Blue	2	Vlog2	Ch_Vlog2	+	⚙️
Dark Blue	3	Vlog3	Ch_Vlog3	+	⚙️
Purple	4	Vlog4	Ch_Vlog4	+	⚙️
Pink	5	Vlog5	Ch_Vlog5	+	⚙️
Red	6	Vlog6	Ch_Vlog6	+	⚙️
Orange	7	Vlog7	Ch_Vlog7	+	⚙️
Yellow-Orange	8	Vlog8	Ch_Vlog8	+	⚙️
Yellow	9	Vlog9	Ch_Vlog9	+	⚙️
Light Green	10	Vlog10	Ch_Vlog10	+	⚙️
Green	11	Vlog11	Ch_Vlog11	+	⚙️
Cyan	12	Vlog12	Ch_Vlog12	+	⚙️
Light Blue	13	Vlog13	Ch_Vlog13	+	⚙️
Blue	14	Vlog14	Ch_Vlog14	+	⚙️
Dark Blue	15	Vlog15	Ch_Vlog15	+	⚙️

Connector pinout			
Pin No.	Name	Pin No.	Name
1	Alarm B	14	Alarm A
2	Alarm D	15	Alarm C
3	GND	16	+12V
4	GND	17	GND
5	GND	18	Vlog16
6	Vlog15	19	Vlog14
7	Vlog13	20	Vlog12
8	Vlog11	21	Vlog10
9	Vlog9	22	Vlog8
10	Vlog7	23	Vlog6
11	Vlog5	24	Vlog4
12	Vlog3	25	Vlog2
13	Vlog1		

Figure 3.13: Digital input: channel table

On this page, you will find a table showing all the digital inputs. Each channel is shown as a row (1). The *position* column defines the corresponding pin on the physical connector. The complete connector schematic with the associated pins is shown on the right-hand pane of the screen to guide your wiring (2).

To open all the parameters of a digital input, press the symbol  from the “Configure” column:



The digital inputs can monitor all signals up to 24V. To increase the maximum permissible voltage, the digital channel box option 917008000 is available.



The switchover threshold is between 1.2V and 2.8V.

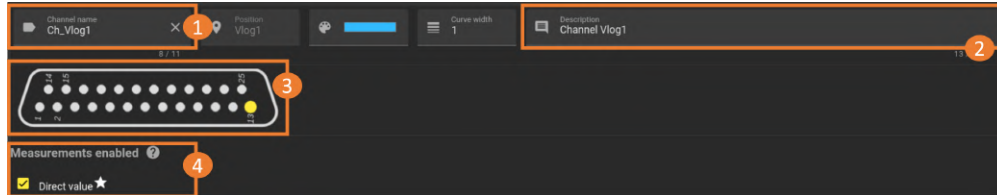



Figure 3.14: Digital input: channel parameters

Field (1) corresponds to the name of the digital channel; you can also add a description in field (2). The pin position on the connector is shown in diagram (3). Next, define the type of measurements to be displayed and/or recorded (4). Note that frequency, counter and PWM measurements will be available in a later version.

You can also activate measurements from the table thanks to the button  from the “Measurements” column.



By pressing the icon shown below, you can duplicate all the parameters of the selected logic input on other channels of the device

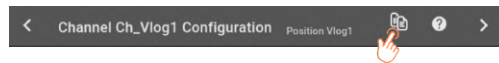
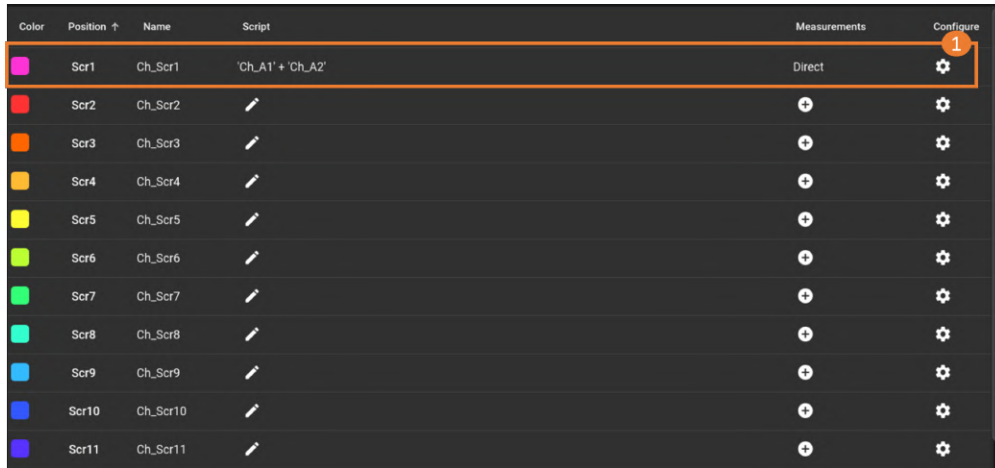

Figure 3.15: Digital input: copying logic input parameters

3.6 | Setting script channels

To access logic channel settings, press “*Configuration*” > “*Channels*” > “*Script*”.



Color	Position ↑	Name	Script	Measurements	Configure
■	Scr1	Ch_Scr1	'Ch_A1' + 'Ch_A2'	Direct	⚙️ 1
■	Scr2	Ch_Scr2		+	⚙️
■	Scr3	Ch_Scr3		+	⚙️
■	Scr4	Ch_Scr4		+	⚙️
■	Scr5	Ch_Scr5		+	⚙️
■	Scr6	Ch_Scr6		+	⚙️
■	Scr7	Ch_Scr7		+	⚙️
■	Scr8	Ch_Scr8		+	⚙️
■	Scr9	Ch_Scr9		+	⚙️
■	Scr10	Ch_Scr10		+	⚙️
■	Scr11	Ch_Scr11		+	⚙️

Figure 3.16: Script channel: table of channels

On this page, you will find a table showing all the script channels. Each channel is shown in a row **(1)**, and the DAS1800 offers the option of setting up to 24 script channels. To open all the parameters of a script channel, click on the symbol  in the “*Configure*” column.

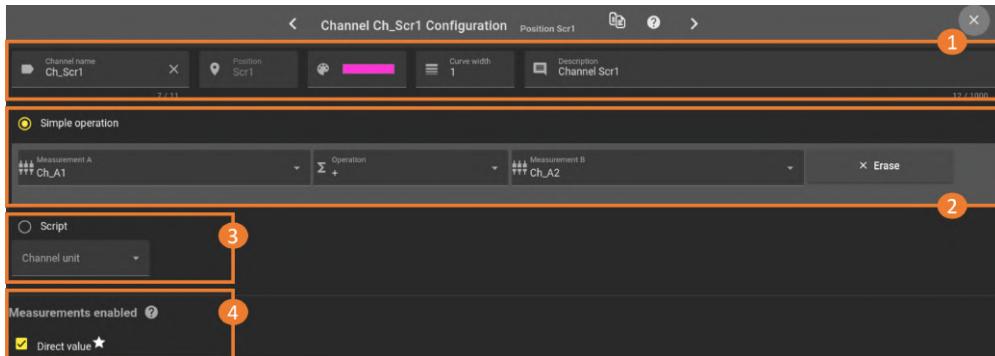

Figure 3.17: Script channel: configuration page

1. Name of the channel displayed on graphics (limited to 11 characters), curve settings (color and thickness), channel description (limited to 1000 characters).
2. Simple function of script channel
3. Advanced “Script” calculation function
4. Measurement activation



Reference channels used in script channels must first be parameterised and enabled. When recording a script channel, the reference channels used will also be recorded.

3.6.1 Simple operation

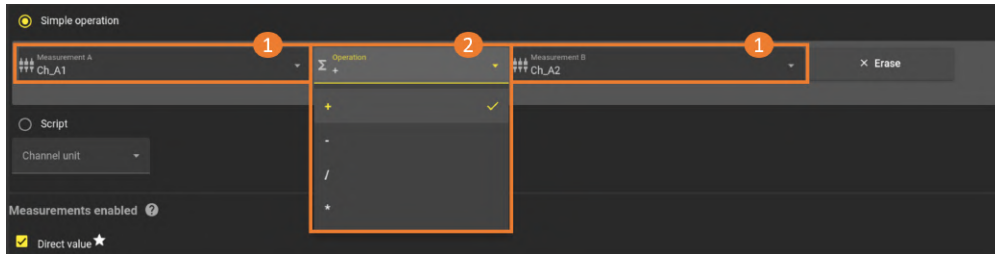

Figure 3.18: Simple operation

This function calculates using simple operations **(2)** (addition, subtraction, division and multiplication) between 2 analog and/or digital channels **(1,3)**

3.6.2 Function script

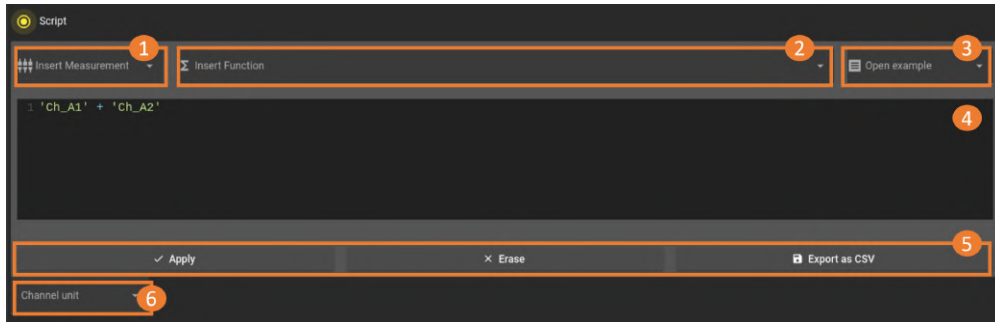

Figure 3.19: Function script

By ticking the “Script” option, the advanced channel settings window opens, allowing you to: choose from a list of examples **(1)** or predefined functions **(2)** (see table 3.1 for details of functions) to facilitate the writing of the operations to be performed on the measurement(s) to be inserted **(3)**.

The calculation script is displayed in the text editor **(4)**, so you can create an advanced function specific to your application, and view, modify or delete certain lines or operations more intuitively.

The banner **(5)** allows you to export in CSV format. Finally, a scroll bar **(6)** lets you select the measurement unit for the script channel.

The language

The language used for scripting channel is the C++ Mathematical Expression Library (ExprTk).

Operator and keyword support:

Basic operation	<code>+, -, *, /, %, ^</code>
Assignment	<code>:=, +=, -=, *=, /=, %=</code>
Equality and inequality	<code>=, ==, <>, !=, <, <=, >, >=</code>
Logical operation	<code>and, nand, or, nor, not, xnor, xor, mand, mor, shl, shr, true, false</code>
Function	<code>abs, avg, ceil, clamp, equal, exp, floor, frac, log, log10 max, min, mul, not_equal, root, round, roundn, sgn, sqrt, sum, trunc</code>
Trigonometric function	<code>acos, acosh, asin, asinh, atan, atanh, atan2 cos, cosh, cot, csc, sec, sin, sinc, sinh, tan, tanh, hypot, rad2deg, deg2grad, deg2rad, grad2deg</code>
Conditions	<code>if (Condition 1) { ... } else if (Condition 2) { ... } else { ... }, return[x]</code>
Comment	<code>// this is a comment</code>
Variable	<code>var ma_variable; var ma_variablle_init := 10; var mon_tableau[5] := {1,2,3,4,5};</code>

Table 3.2: Operator and keyword support script channel



See the following reference site for more details:

<https://www.partow.net/programming/exprtk/index.html#design>

Limitations

There are a few limitations that must be respected in order to obtain correct results:

- Variable names must not correspond to a keyword or function in the language.
- Loops (For, While ...) are not supported
- Recursivity is forbidden
- Static variables are not supported
- A script channel cannot be used in another script channel

3.6.3 Operation

On real time display

For display in DMM mode and on the chart in scroll mode (time base > 100ms/div), script channels are calculated from the source channels sampled at 5Khz.

For display on the graph in synchronized mode (time base < 100ms/div), script channels are calculated from the points displayed on the screen.

On recording

Record files only contain the source data used by the various scripts. Script channels are calculated each time the file is opened. Dependencies are managed automatically. The channels used in scripts are automatically added to the record group in which the script channel is present.



If several script channels use the same source channel, it is recorded only once if the different script channels are recorded at the same frequency.



The use of script channel considerably increases the time taken to open files on the DAS. We recommend that you use DASPRO to process these files, to take full advantage of your computer calculation power.

3.7 | Recording measurements

3.7.1 Recording file configuration

Recording file configuration is available from the menu *"Configuration" > "Records" > "File info"*

File name

The file name is a string of characters. All the alphanumeric characters are allowed, with the exception of the following characters: " / | \ * : ? < > .

The file extension is .mf4 and is not configurable. It corresponds to the MDF4 (Measurement Data Format) recording format, from the standard ASAM (Association for Standardization of Measuring Systems).

Date suffix

If the box is checked, the file name will be automatically followed by the date and time of the start of recording (pressing the "Start recording" button, independently of any triggers) in the following format: `_yy-MM-dd_HH_mm_ss_zzz`, :

- yy → Last 2 figures of the year
- MM → issue of the month
- dd → day of the month
- HH → hours in 24h format
- mm → minutes
- ss → seconds
- zzz → milliseconds

For example, if the filename is set to "RecordFile" and the "Suffix by date" box is checked, we could have a file called: `RecordFile_23-01-28_15_02_28_792.mf4` corresponding to a record from 28/01/2023 at 15:02:28.792.



Caution: If the "Suffix by date" function is deactivated, you must manually change the file name for each recording, **otherwise the last recording will systematically overwrite the previous one and you will lose your data**. We strongly recommend that you keep this function enabled to avoid any loss of recordings.

Recording file size or duration limit

In addition to triggers, it is also possible to add a limit to the recording file. For instance, it can be used, to avoid obtaining a very large file if the event associated with the end-of-recording trigger is never reached.

- If the "Enable record file size limit" checkbox is disabled, the DAS records for the maximum duration (available disk space).
- If the box is checked, the user can configure the limit in 2 different ways:
 - Memory size on disk → if the channel configuration changes (addition or deletion of measurements, change of recording frequency), the size limit will be retained and its equivalence in recording duration will be re-evaluated
 - Recording duration → if the channel configuration changes, the recording duration will be retained and the size of the recording file will be reassessed.



Please note that if you add measurements or increase the recording frequency, the corresponding file size will increase while retaining the recording time. The system will then limit the size to the available disk space, and the recording time cannot be retained.



Regardless of the setting for this limit, a warning message is displayed when the available disk space is less than 5%.
Recording is automatically stopped when the available disk space is less than 10GB.

User information

The user can add a certain amount of information to be included in the registration file:

- Author
- Department
- Project
- Subject
- Comments

Each of these fields is a character string. They can be left empty, but this has no influence on the file name or the recording sequence.

Parallel recording to multiple files simultaneously

It is possible to define up to 4 files (DAS1800) that will be recorded simultaneously. To do this, simply click on the + button (1) at the top of the page.

All file settings will then be duplicated: each file can have a different name, a suffix or not, a size limit or not, etc. (2). The independence goes further: each file can have a different recording frequency, trigger and rearm conditions.

However, the file viewer can only open one file at a time, so you can only follow one of the 4 files live on the same screen. It is of course still possible to switch the display from one to another (but only one at a time).

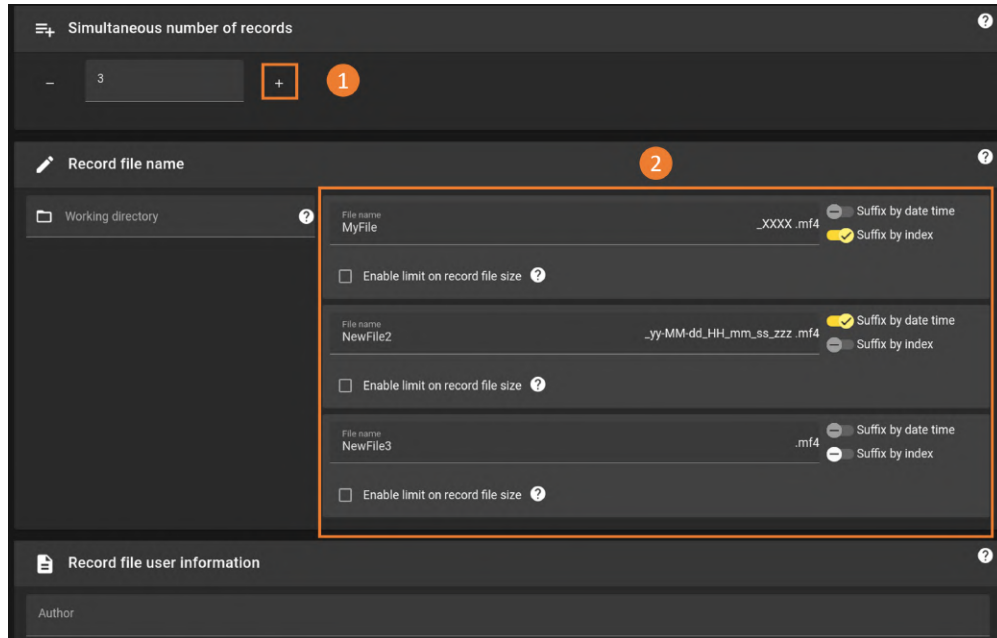

Figure 3.20: Enable simultaneous recordings

3.7.2 Sampling frequency

To set the recording frequency, go to “*Configuration*” > “*Recording*” > “*Recording frequency*”. You can customize the information displayed on the screen in field (1), or filter the channel display in field (2) for better table visibility. 3 different recording frequencies can be set (3).

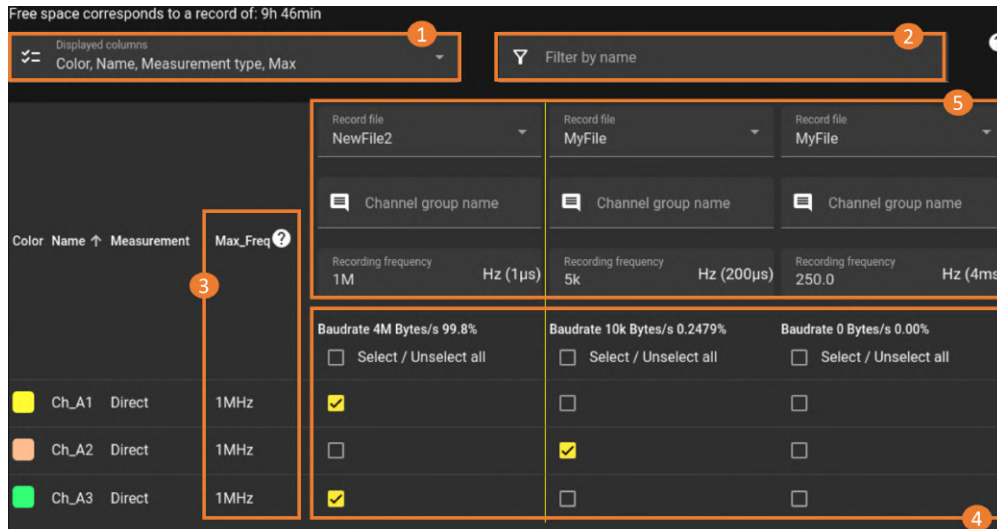

Figure 3.21: Setting recording frequencies



The same measurement can be recorded at a single frequency. Two measurements in the same channel may have different recording frequencies (4). Recording periods are rounded to the nearest μs . Only activated measurements can be recorded.

In the example shown in the table, the direct voltage measurement of channel A1 is recorded at 1MHz, while the RMS measurement of the same channel A1 is recorded at 5kHz. All the other measurements shown in the table can be viewed in real time, but are not recorded, as they are not activated in a frequency group.



The sampling frequency is limited and depends on the acquisition card used (1MSa/s for the universal card). It is independent of the recording frequency. For example, if a recording is set to 1kSa/s on a universal card, the trigger will still be accurate to $1\mu\text{s}$. Calculations are based on all samples present in the period Δt . Depending on the type of measurement recorded and the acquisition card used, a maximum refresh rate is calculated in column (5). If the user-defined recording frequency is higher than this value, the measurement will be oversampled. The same measurement point will be sampled several times, which can lead to a "plateau" effect on the measurement curve. It is therefore recommended not to exceed this limit. Depending on the configuration, an optimum recording frequency is proposed by default to avoid this behaviour.

The throughput per recording group is displayed in bytes/second and as a % of the total recording throughput; this percentage is an image of the size that the data from each recording group will represent in the file.

In our example, 100% of the recording file size will be occupied by channels D1 and F1.



The overall throughput (sum of the throughput of the 4 groups) is limited to 50MB/s. The speed of the 1st group is limited to 40MB/s, the other groups are limited to 10MB/s each.

Simultaneous recordings

Please note that the configuration page is limited to a total of 3 columns. You can freely assign columns 1 to 3 per file (1). Yellow lines appear to mark the separation between files (2).

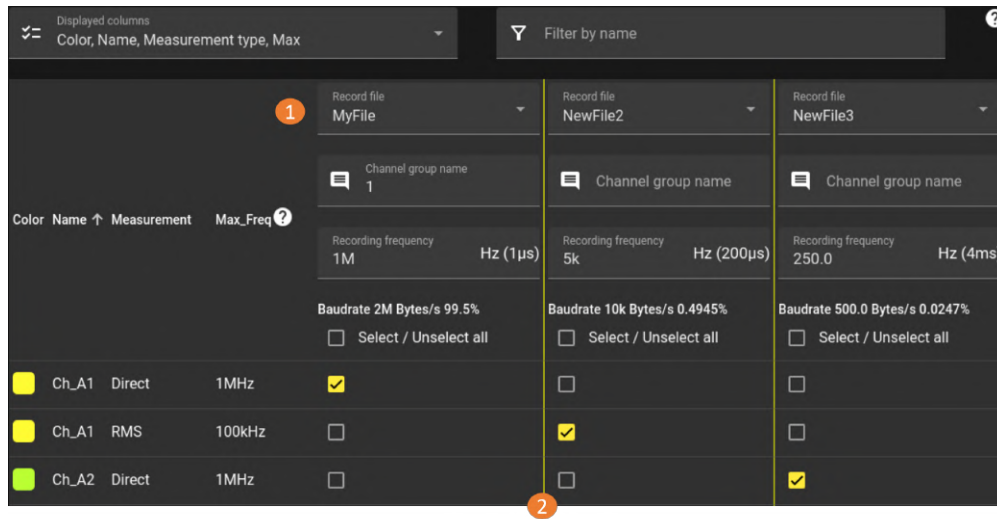

Figure 3.22: Setting the frequencies on simultaneous recordings



Be sure to assign at least one column to each file, activate one or more measurements, and set the recording frequency so that you do not end up with empty files.

3.8 | Start and stop settings

To set your acquisition trigger conditions, go to “*Configuration*” > “*Records*” > “*Trigger*”.

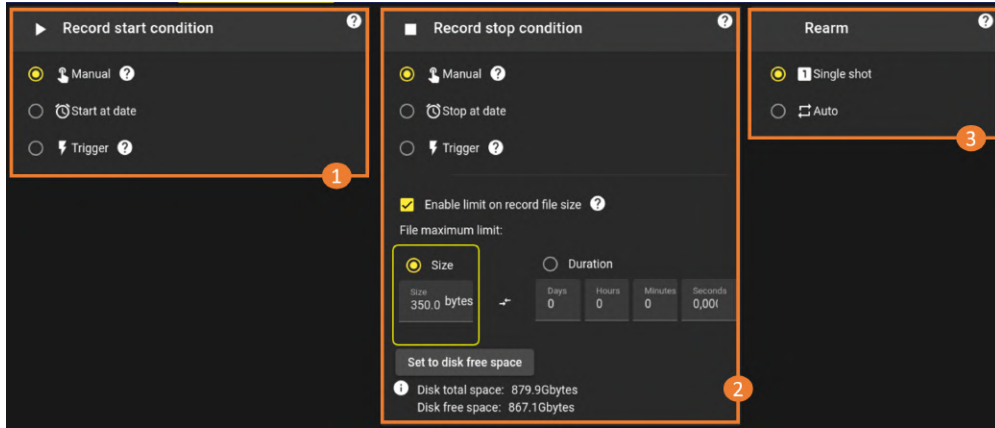

Figure 3.23: Triggers settings

Each recording must be configured with a start condition and a stop condition. Start condition **(1)**, the recording can be started in one of three ways:

- Manually via the touch button on the screen,
- Automatically at a set date and time,
- By a trigger signal, such as a rising edge detected on an analog input.

The options for stopping recording **(2)** are similar to those for starting: manual, programmed or by signal. It is also possible to define a file size or duration limitation. This option allows you to :

- Create a fixed file size (e.g. 2 GB)
- Or limit recording time (e.g.: 1 day and 12 hours).

An automatic reset function **(3)** can be activated to automatically restart a new recording once the previous one has ended.

3.8.1 Manual

Users can start and stop recording themselves, using the start/stop button at the top right of the screen.

3.8.2 Start and Stop at date

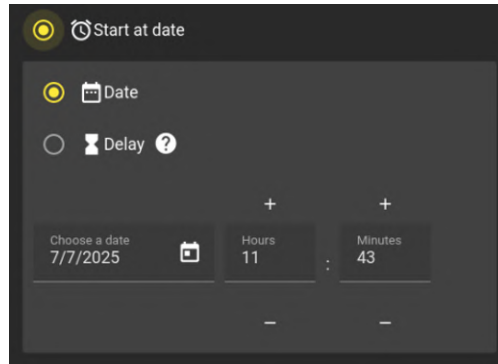

Figure 3.24: Start at date

The user can define a calendar date at which recording starts and/or stops. Alternatively, you can set a timer before recording (start condition) and/or a recording duration (stop condition).

3.8.3 Signal trigger

Level :

The user can program recording start and stop conditions according to the values measured on the analog and digital channels:

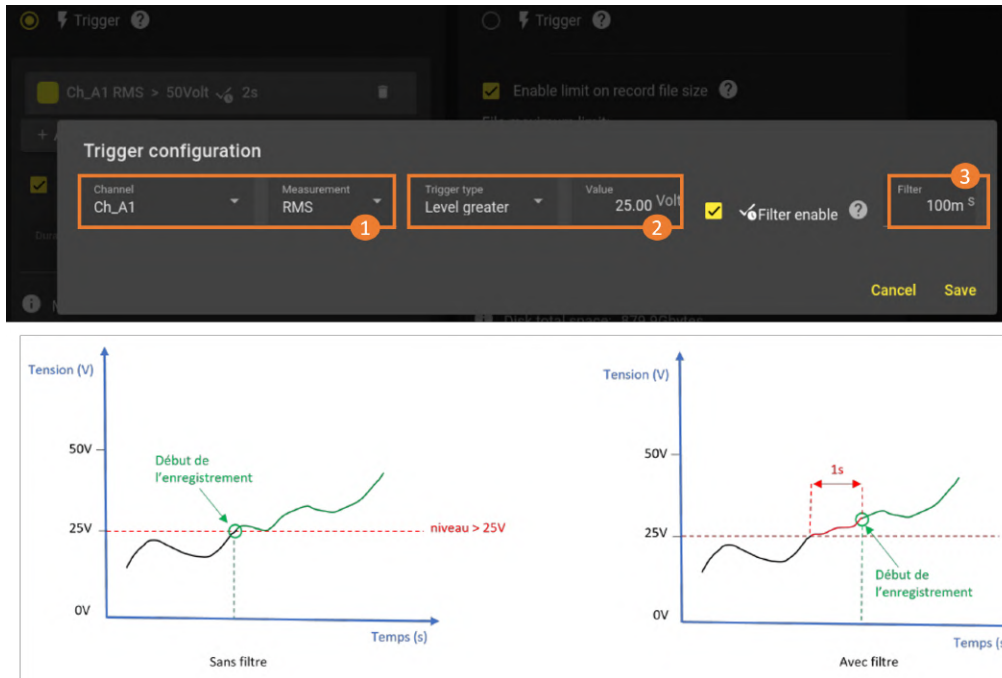

Figure 3.25: Trigger on level

1. First select the measurement channel (physical channel) and associated measurement to which you wish to apply the trigger condition.
2. Then define the trigger condition. Select “Level” as the condition type.
 - (a) Select the upper or lower logical operator, depending on the desired overshoot direction.
 - (b) Enter the threshold value at which triggering is to occur

Example: If you configure channel A2 with the measurement “Direct Voltage”, a threshold value of 25 volts and the operator “greater than”, recording will be triggered automatically when the voltage measured on channel A2 exceeds 25 volts.



It is possible to activate a filter on this condition. In this case, the user defines a delay during which the condition must remain true for the condition to be validated. In the example above, exceeding the 25 volt threshold must last at least 100 milliseconds for recording to start/stop **(3)**. The filter prevents unwanted triggering caused by transient interference on the channel.

Edge trigger:

1. First select the channel (physical channel) and the associated measurement to which you wish to apply the trigger condition.
2. Then define the trigger condition. Select “Rising edge” or “Falling edge” or “Both edge” as the condition type depending on the desired overshoot direction.
3. Enter the threshold value at which triggering is to occur.

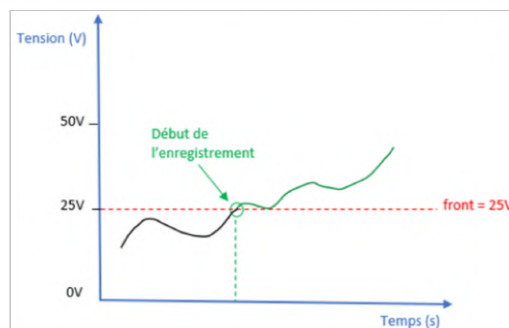
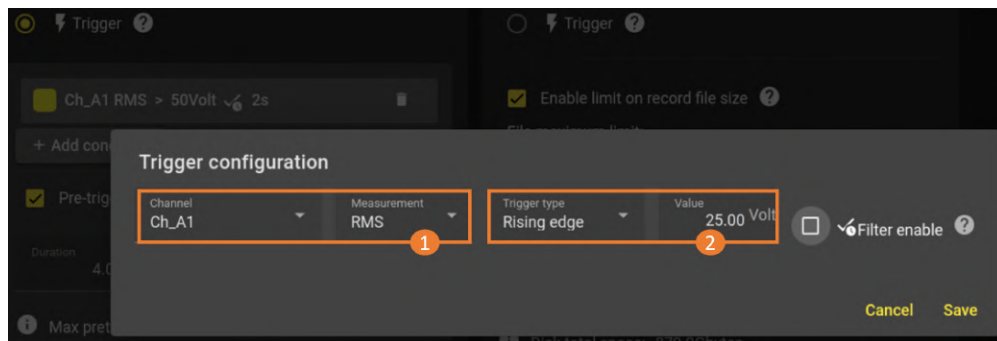

Figure 3.26: Edge trigger

Example: If you configure channel A2 with the measurement “Direct Voltage”, a threshold value of 25 volts and the operator “rising edge”, recording will be triggered automatically when the voltage measured on channel A2 rises above 25 volts.

Window :

1. First select the measurement channel (physical channel) and associated measurement to which you wish to apply the trigger condition.
2. Then define the trigger condition. Select “Window in” or “Window out” as the condition type.
 - (a) Enter the lower threshold value defining the lower value of the measurement window.
 - (b) Enter the upper threshold value defining the upper value of the measurement window.

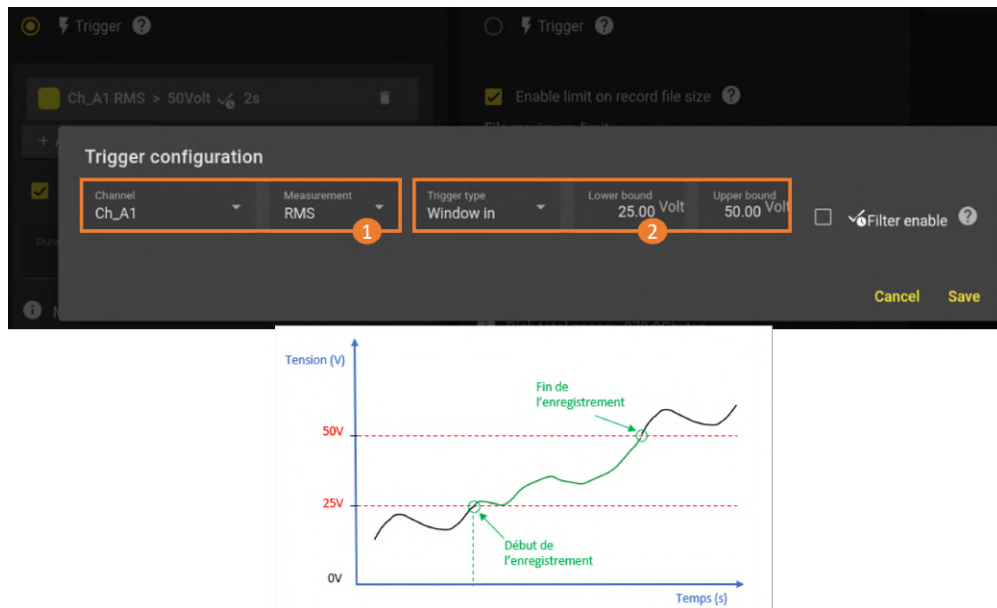

Figure 3.27: Windows trigger

Example: If you configure channel A2 with the measurement “Direct Voltage”, a lower threshold value of 25 volts and an upper threshold value of 50 volts, and the operator “inner window”, recording will be triggered automatically when the voltage measured on channel A2 is between 25 and 50 volts.

Combination of trigger conditions

It is possible to combine several conditions on several channels which, once verified, will start/stop recording. When several conditions are set, the user selects the "AND" or "OR" connector:

- AND: All defined conditions must be true simultaneously for recording to start/stop.
- OR: At least one of the defined conditions must be true for recording to start/stop.



The set of conditions can include both analog and digital channels. It is also possible to have two different conditions on two measurements of the same physical channel. Trigger start and stop conditions can be set independently.

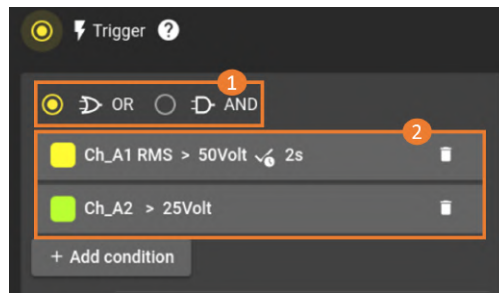

Figure 3.28: Combination of conditions

Example: If one of the defined conditions is true **(1)**, then recording is triggered. If the value of channel Ch_A1 RMS is greater than 50V for more than 2 seconds, or if the voltage of channel Ch_A2 is greater than 25V, recording is triggered **(2)**.

3.8.4 Pre-trigger

When the start-of-recording condition is a trigger or a combination of triggers, the user can configure a pre-trigger. This corresponds to the time recorded before the trigger condition becomes true. The user can set the duration of this window. Please note that if the event occurs during the pre-trigger time, its duration will be less than that defined unless the inhibit option is enabled.

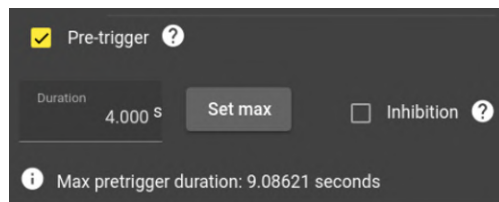

Figure 3.29: Pre-trigger

Example:

- 60s pre-trigger without inhibition: Event occurs from 15s, recording will start and the pre-trigger will only be 15s long.
- 60s pre-trigger with inhibition: Event occurs from 15s, recording will not start. The event must occur again after 60s to be taken into account; recording will start and the pre-trigger will be 60s as defined by the user.

If Inhibition is enabled, triggering is ignored if the pre-trigger window is not full :

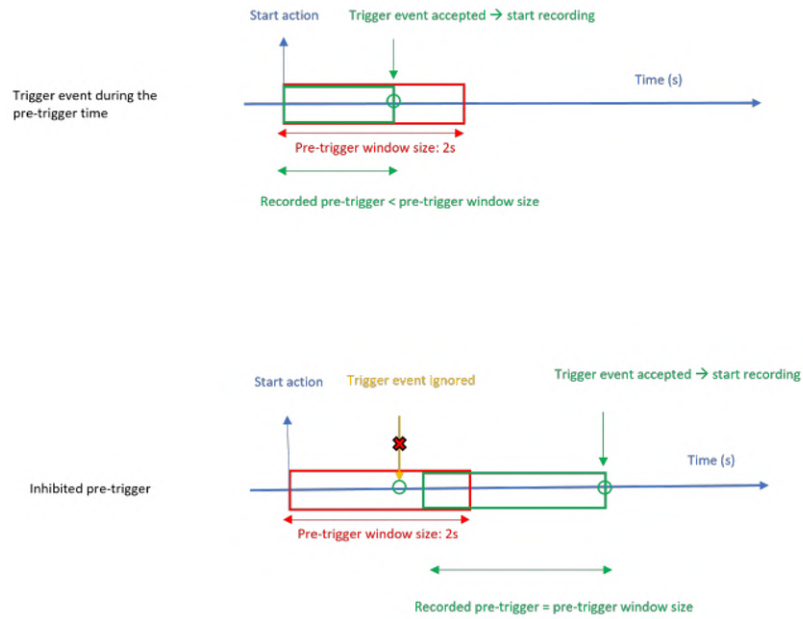

Figure 3.30: Inhibit function

3.8.5 Post-trigger

The user can set a time during which the device continues to record after the stop condition has been triggered.

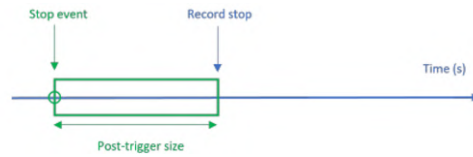

Figure 3.31: Post-trigger

3.8.6 Rearm

The user can choose the reset mode:

- Single: Recording stops when the stop trigger condition is true or on user action.
- Auto: Recording stops when the stop trigger condition is true. Once the file has been saved, recording is restarted automatically (as if the record start button had been pressed again). If a start condition is activated, recording waits for a trigger as long as the start condition is false.



In automatic rearm be sure to have enabled the “suffix by date-time” option of the record file to prevent the current record file from erasing the previous one.



Split easily your continuous records with the rearm feature:

- Select a manual start
- Set the stop on a 1-day duration
- Activate the automatic rearm to get one file per day

3.9 | Setting save

To create a configuration file, go to “*Configuration*” > “*Import/export*” > “*Import/export parameters*”. You can save all the configuration parameters in two files, which can be recalled later by importing them from memory :

Fichier .acq_cfg : parameters (1)

- Measurement parameters (measured phenomenon, range, sensor, channel color, etc.)
- Recording parameters (recording frequency, triggers, file name)
- Settings for real-time pages



Please note that when you import a configuration, the device makes a local copy, so your changes to the configuration do not affect the source file. If you wish to edit the source file, you must export it again after making your changes.

Fichier.sys_cfg (2)



When a configuration file is created, it is linked to the type and location of the measurement modules in the device. If the device configuration changes, the file is no longer compatible.

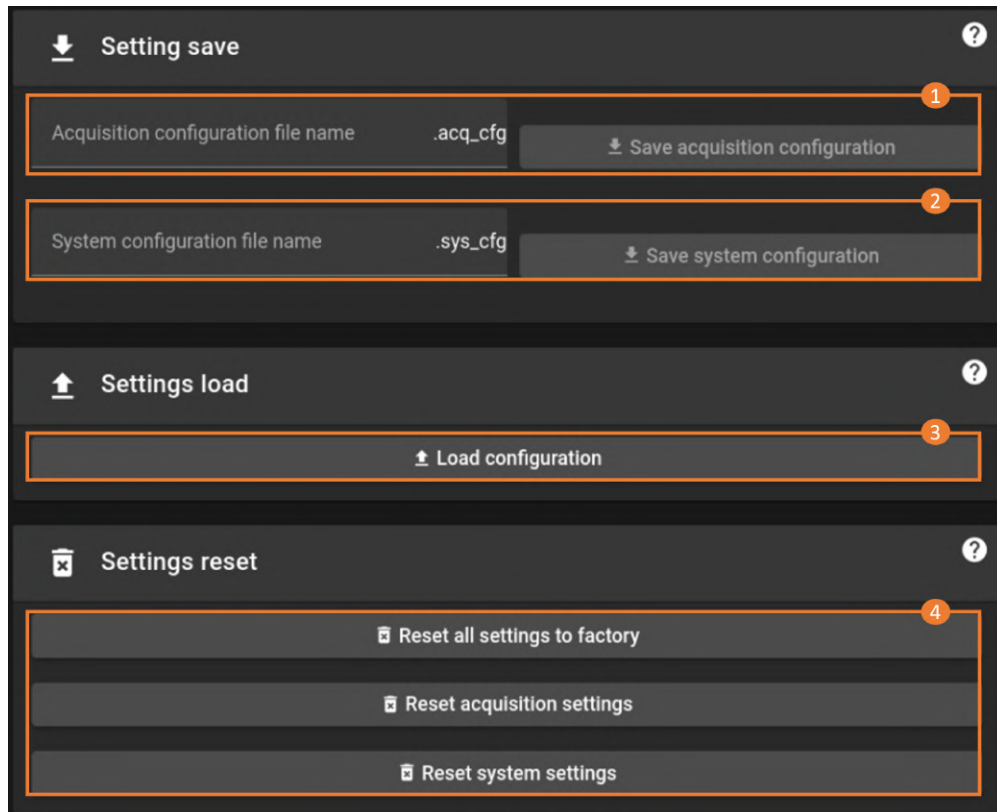

Figure 3.32: Creation of a configuration file

You can recall the desired configuration file by pressing “restore configuration” (3) or reset the default configurations (4).

3.10 | External sync

The external synchronisation channels are located on the sub-D15 connector on the device. To access the logic channel settings, press *Configuration > Sync > External sync*. These are trigger signals for other devices linked to the recording in progress.

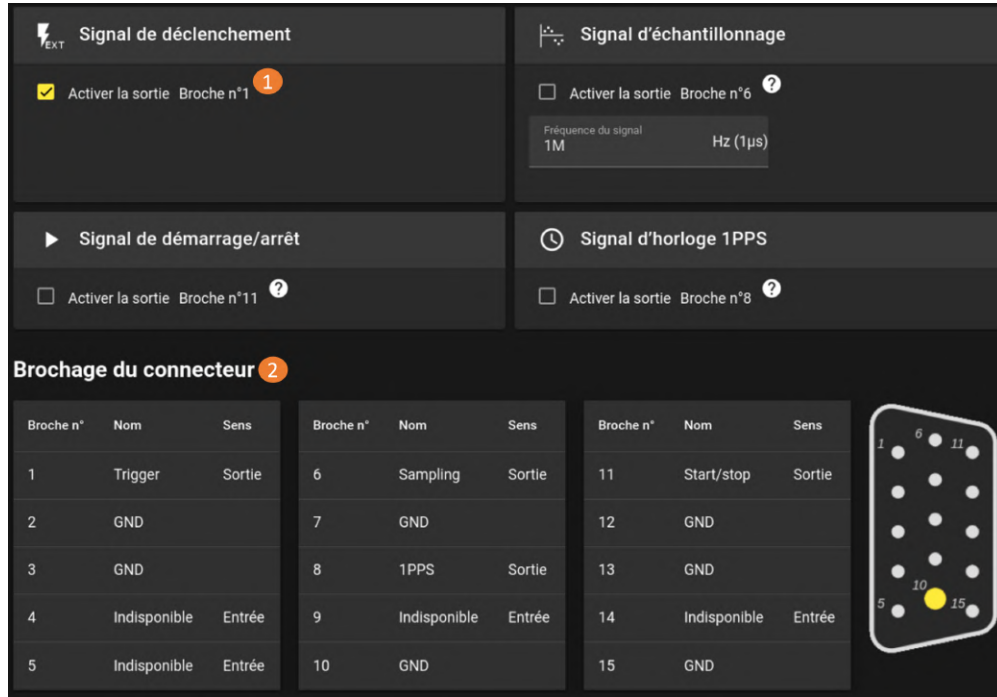

Figure 3.33: External sync menu

On this page, you'll find the management of all external synchronized outputs. Activate the output by ticking the "Activate output" buttons, while parameterization is done directly by selecting the output itself (1). The complete connector diagram with associated pins is provided to guide your wiring (2). External synchronized outputs consist of :

PPS

The PPS (Pulse per second, pin 8 Ext sync 1PPS on the connector) sends a 100ms signal at a fixed frequency of 1Hz, i.e. once a second. This is a slow clock linked to the device's internal clock. When the output goes to 1, the signal sent is 3.3V and when it goes to 0, the signal is 0V.

Sampling

Sampling (pin 6 Ext sync sampling on the connector) generates a clock signal based on the DAS acquisition signal, 50% duty cycle, Frequency: 1Mhz - 0.5Hz (Period rounded to the μ s). It is used to tell when data is being recorded, if it is set to the same frequency as the recording (chapter 3.6.2). When the output is set to 1, the signal sent is 3.3V and when it is set to 0, the signal is 0V.

Start / Stop

The Start/Stop (pin 11 Ext sync start/stop on the connector) is a signal indicating the start of recording (manually by pressing the start button or automatically via the reset or remote control). When the device is on stand-by or after recording has been stopped (by pressing the Stop button), the output signal is 0V. When recording is active, the signal sends a voltage of 3.3 V. The chronogram below shows how Start/Stop works in manual mode, in other words without programming the trigger.

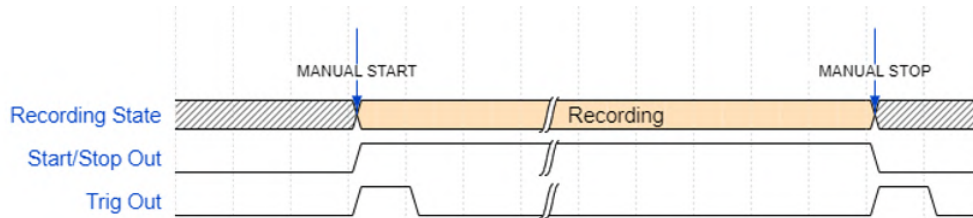

Figure 3.34: Chronogram Start/Stop



If the rearm is enabled, the Start/Stop signal drops to 0V between two files.

Trigger

The trigger (pin 1 Ext sync trigger on the connector) is a brief 1 ms signal at each manual or programmed trigger, at the start or end of a recording. When the trigger is on stand-by, the output signal is 0V; when it is active, the signal sends a voltage of 3.3V.

The chronogram below illustrates the operation in the case of a recording start (START) with a trigger on signal and a recording end (STOP) on signal with a post-trigger.

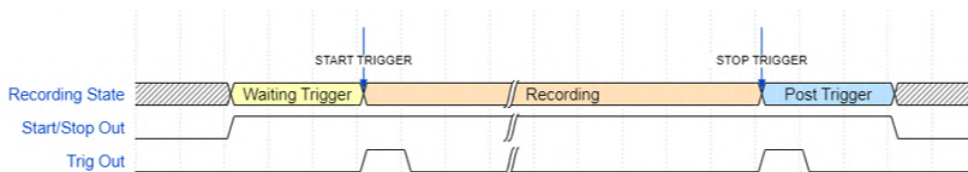

Figure 3.35: Chronogram Trigger

Chapter 4

Measurement data display

4.1 | Real-time display

To view your measurements in real time, click on the "Realtime" tab in the main navigation bar :

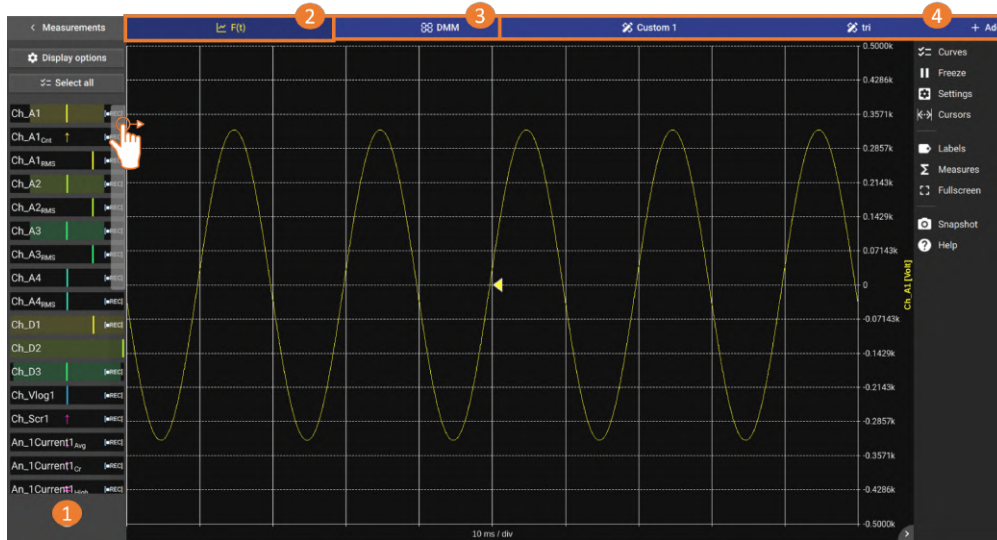

Figure 4.1: Real-time data display

To view previously configured measurements, “drag and drop” them from the measurement bar graph into the graphics area. (1).



You can also add or remove a measurement from the graph area by pressing and holding in the graph area. It will open a pop-up where you can select the data to display.

There are 4 real-time display modes:

- *F(t)*: Oscilloscope mode to display measurements as a function of time in the form of a waveform (2).
- *DMM*: Multimeter mode for displaying the current numerical value of one or more measurements as numerical values (3).
- *Custom*: Customizable display to show measurements as curves and numerical values (4). Customized screens can be created using the “+Add” button.

4.1.1 F(t) : Oscilloscope

See section: [Visualization and graphical analysis](#) for details on the functionality of the graph widget.



Figure 4.2: F(t) in oscilloscope mode

The real-time F(t) display has several display behaviors:

- For time bases between 100ms/div and 10min/div, the display is in scroll mode
- For time bases between 20 μ s/div and 50ms/div, the display is in synchronized mode (oscilloscope). This mode displays one or more periods of a periodic signal. The arrow in this mode lets you select the level and position of the trigger point. Clicking on this arrow selects the signal edge to be displayed (rising or falling) and the source signal.



The display is automatically refreshed after one second if no edge is detected by the trigger.

4.1.2 DMM display

DMM mode displays real-time measurements in digital format. In order to be human readable, the value displayed is an average.



You can use the HDMI output of the device to transfer the image to an external screen.

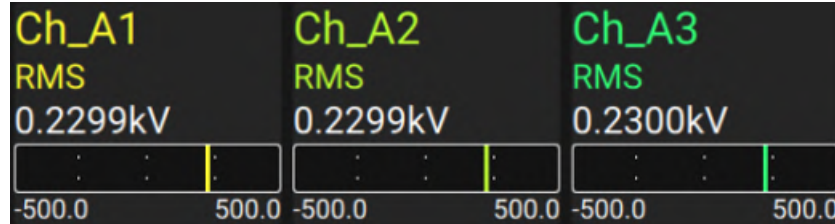

Figure 4.3: DMM display

To display measurements in numerical format, simply press and drag the measurement onto the graphics area. A bar graph indicates where the measured value lies in relation to the defined range.



Press on a measurement to access channel settings, recording frequency and averaging period.

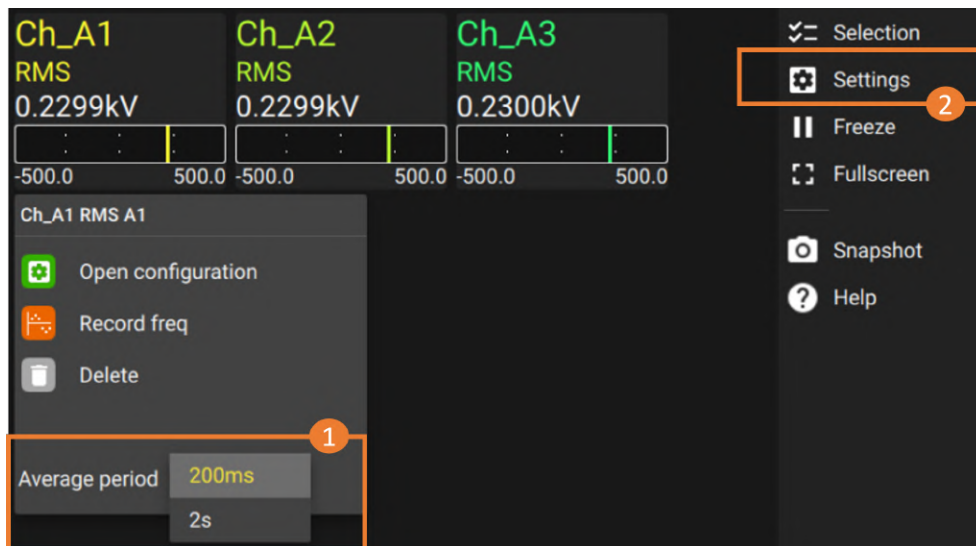

Figure 4.4: Averaging period DMM

The averaging period **(1)** of the DMM can be 200ms or 2s. The number of samples for averaging depends on the speed of the acquisition card used. For example, with a universal card, it will be 1 Msample/s.

This window also allows you to define one or more value ranges for which the DMM will be highlighted (in the color of your choice). This allows you to create a visual alert when a threshold is exceeded, for example. The ranges cannot overlap. The last one created will then take priority over all the others. You can freely add, delete or edit any range for each DMM (see next figure).

Parameters **(2)** allow you to adjust display modes and formats. For example, you can integrate maximum and minimum values, or refine precision by increasing the number of decimal places after the formula.

Example of displaying the value 1234V with a 2 digit precision:

- SI prefixes → 1.23kV
- Scientific → 1.23e+03V
- Fixed → 1234.00V

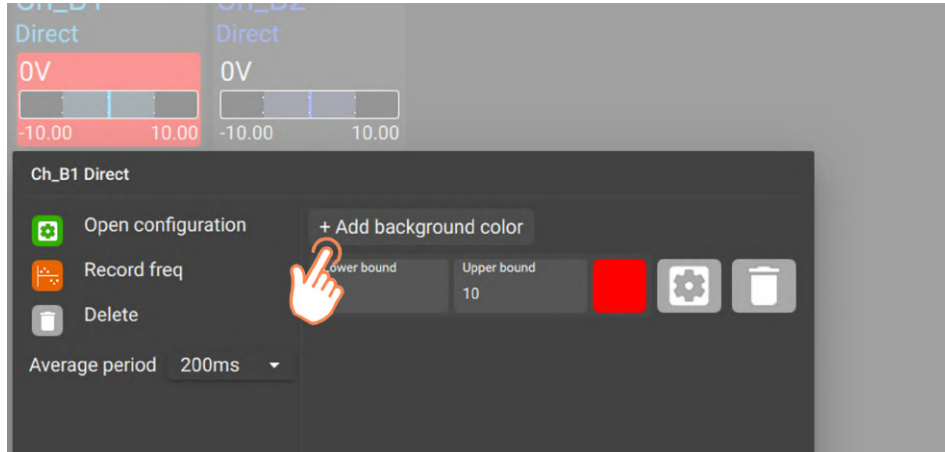

Figure 4.5: Adding an overlay on DMM

4.1.3 Custom display

Dashboards are fully customizable and saved when the configuration is exported. Up to 16 widgets can be displayed simultaneously. These widgets can be of different types, with accessible pre-configurations.

- DMM: numeric format
- F(t): Scrolling waveform display
- Live record: Full waveform display
- Image: import an image in jpg, png or svg format



The widgets and layout parameters allow you to create a synoptic supervision dashboard.

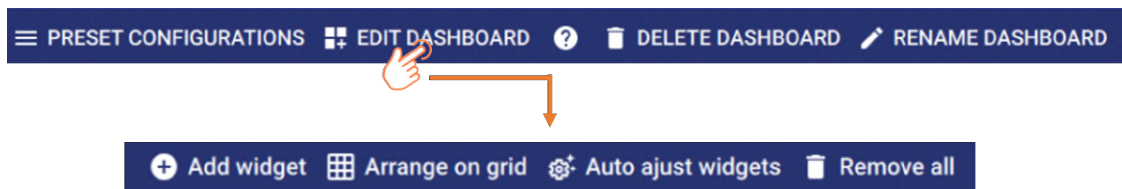

Figure 4.6: Dashboard personalization

- Preconfiguration: access to preconfigured screens in the DAS1800 database
- Edit dashboard: access to edit mode to perform actions on Custom screen
- Delete dashboard: delete custom screen
- Rename: change the default screen name
- Add widget: create an additional widget; default grid layout
- Divide on grid: set all the widgets at the same size and place them on a grid layout (e.g. 2x4 if you have 8 widgets)
- Auto widget adjustment: slightly adjusts the size of adjacent widgets to eliminate gaps
- Remove all: removes all widgets from the dashboard

To redesign widgets you can :

- In touch navigation: in edit mode, pinch to change size and drag to move.
- Mouse navigation: in edit mode, use the scroll wheel to change size and drag to move.



Go to “Size and position” to resize on a single axis at a time.

4.2 | Visualization and graphical analysis



The user interface for viewing $F(t)$, or analyzing a recording on the device or on a PC (via DASpro software) is similar.

You can download the DASpro software from your DAS1800's web server by clicking the "DOWNLOAD DASPRO" button.

To display the measurement, drag-and-drop it into the graph area **(1)**, and adjust the desired scale using the various touch gestures:

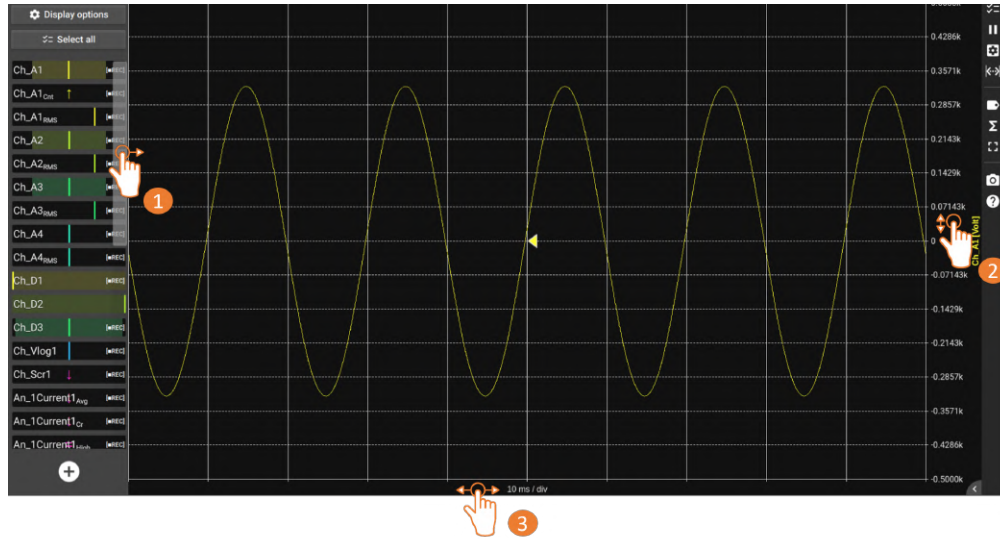

Figure 4.7: Min and max settings for X and Y axes

You can set the minimum and maximum limits by sliding on the axis **(2)**. The same applies to the x-axis (time) **(3)**.



A short press on each axis opens a settings window, where you can manually enter the limits. From this menu, you can, for example, perform an "auto zoom" on the Y axis to automatically center the measurement, or add an additional scale on the Y axis.

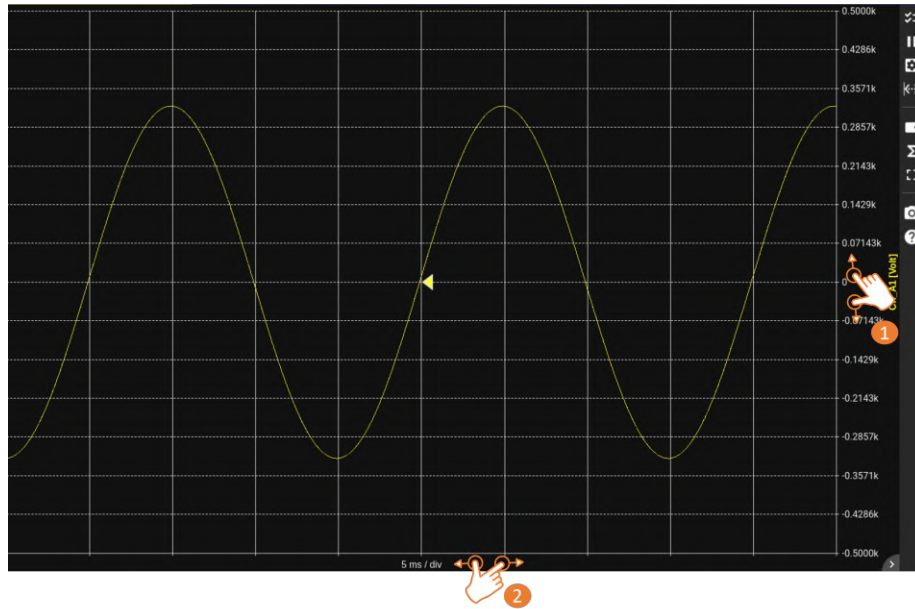

Figure 4.8: Zooming in and out on X and Y axes

By moving the thumb and forefinger closer or further apart on the Y ordinate axis (amplitude), it is possible to zoom in and out between the defined limits (1). The same applies to the X-axis, to change the time base (2).



On a computer or if a mouse is connected to the device, use the mouse wheel to perform this function, positioning the cursor on the desired axis.

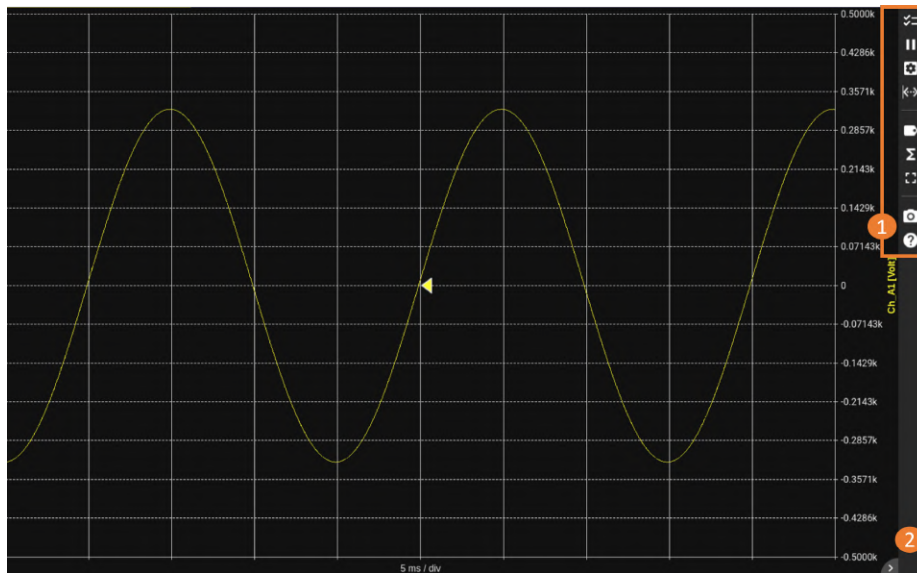









Figure 4.9: Graphic display parameters

On the vertical bar to the right of the screen, a set of parameters is available (1). Use the arrow at the bottom right of the screen to open the text description of each parameter (2).

Symbol	Description
	Selects the measurements to be displayed in the graphics area
	Allows you to set display parameters: division of the graphics area into several screens, choice of colors, background image, etc.
	Shows/hides vertical and horizontal cursors
	Displays/hides full name of displayed measurement(s) with access to display parameters
	Displays/hides predefined mathematical calculations in real time
	Displays/exits full-screen mode
	Opens the help window

4.3 | Mathematical calculations

This function lets you select a type of mathematical calculation on one or more channels, or perform several calculations on the same channel. The function is activated in the F(t) menu on the "RealTime" main page.

4.3.1 Definitions

Then press the "Measures" button in the pane to the right of the graph to open the calculation window. by pressing the "Σ Measures" the "Measures" window (1) on the graph.

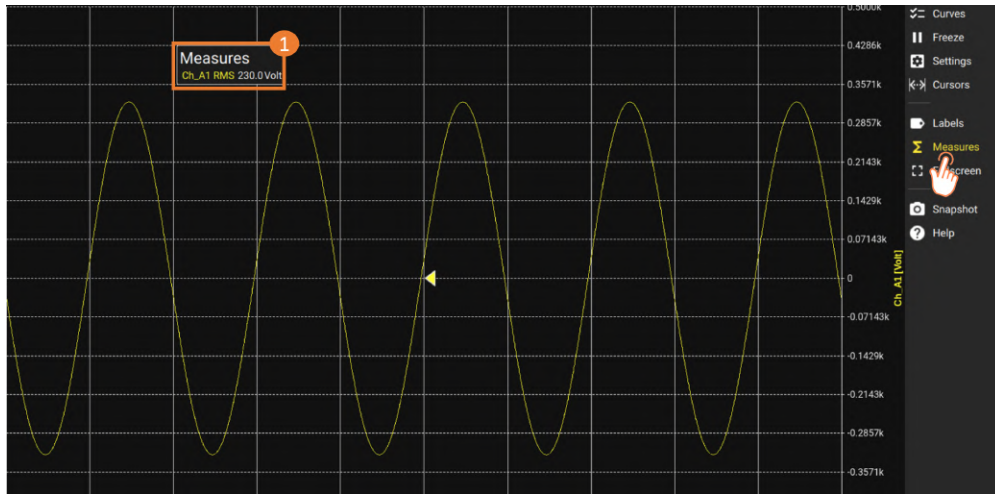

Figure 4.10: Measurement function

Click on the "Measures" window to open the calculation settings manager.

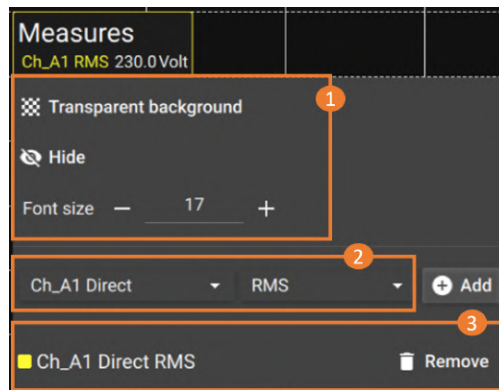

Figure 4.11: Calculation settings

1. Window display management
2. Select the channel and measurement type, then press the "Add" button to display the selected measurement.
3. List of measurements displayed on the F(t) screen



The calculation takes into account only the values displayed on the screen. If you use vertical cursors, the window will change its name to "Measure between cursors", and the calculation will take into account only the values between the cursor boundaries.

The display is in a rectangle above the diagrams, in which :

- Channel and measurement name
- Calculation type
- Calculation value

The calculations are performed in real time and the display of the results is updated every 300 ms. The calculation is done on the 1000 points displayed on the screen. The resolution in time is therefore 0.1%.



The mathematical calculations take into account all the points of the measurement displayed on the screen. In order to not corrupt the result of the calculations, it is necessary to adjust the time base (ZOOM feature) to get closer to the real shape of the signal. If vertical cursors are displayed, the calculation will only take into account the points between the cursors.

4.3.2 Type of calculation

20 different mathematical calculations are offered, divided into 3 categories:

- Amplitude: minimum, maximum, peak-to-peak, low, high, amplitude, over oscillations
- Time: frequency, period, rise and fall times, positive and negative widths, positive and negative duty cycles
- Calculation: mean value, cyclic mean, RMS and cyclic RMS

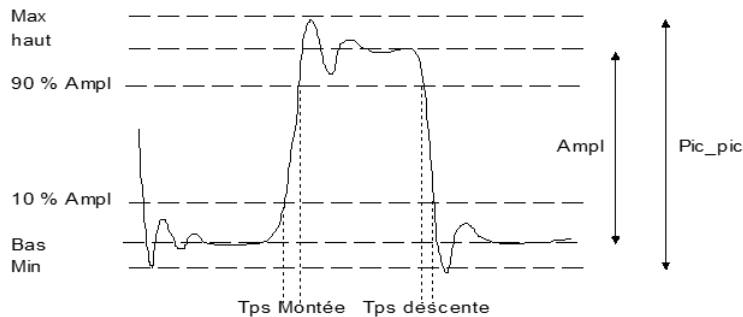
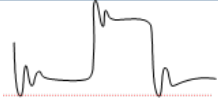
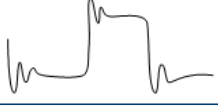
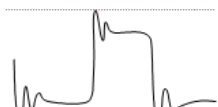
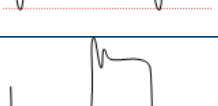
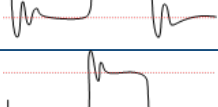
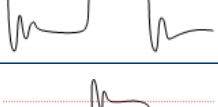
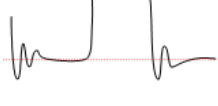
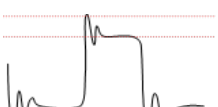

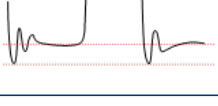
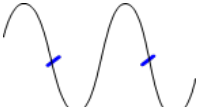
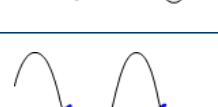

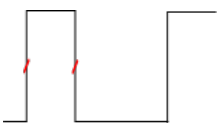
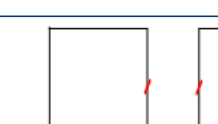
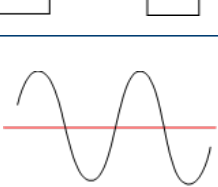
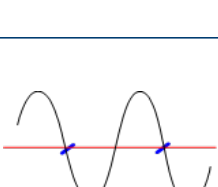
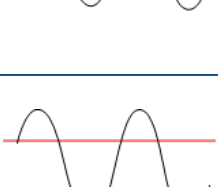
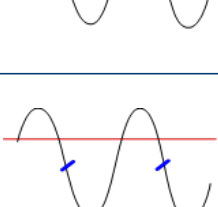

Diagram	Math functions	Calculation	Comments
	Minimum		This is the lowest peak of the negative voltage
	Maximum		This is the highest positive voltage peak
	Peak to Peak	$Max - Min$	
	Bottom		This is the most common value beyond the center.
	Top		This is the most common value beyond the center.
	Amplitude	$Top - Bottom$	
	Positive overshoot	$\frac{Max - Top}{Amplitude} \times 100$	
	Negative overshoot	$\frac{Bas - Bottom}{Amplitude} \times 100$	
	Frequency	$\frac{1}{Period}$	Average frequency
	Period	$\frac{N \text{ Duration full period}}{N}$	Average duration of a complete cycle calculated over as many periods as possible
	Rise time	$T1 = 10\% \text{ Amplitude}$ $T2 = 90\% \text{ Amplitude}$ $Rise \ time = T2 - T1$	
	Descent time	$T1 = 90\% \text{ Amplitude}$ $T2 = 10\% \text{ Amplitude}$ $Rise \ time = T2 - T1$	

	Positive pulse width	<i>Measures the time of the 1st positive pulse. It is performed at 50% of the amplitude</i>	
	Negative pulse width	<i>Measures the time of the 1st negative pulse. It is performed at 50% of the amplitude</i>	
	Positive duty cycle	$\frac{\text{Positive pulse duration}}{\text{Période}}$	
	Negative duty cycle	$\frac{\text{Negative pulse duration}}{\text{Period}}$	
	Average	$\text{Moy} = \frac{1}{N} \times \sum_{i=1}^N V_i$ <i>N : Total number of points</i>	Calculation over the entire graphical window
	Cyclic average	$\text{Moy} = \frac{1}{(N_2 - N_1)} \times \sum_{i=N_1}^{N_2} V_i$ <i>N2 - N1 : Number of points between whole periods</i>	Calculation over as long a period as possible
	RMS	$\text{RMS} = \sqrt{\frac{1}{N} \sum_{i=1}^N (V_i)^2}$	Calculation over the entire graphical window
	RMS Cycle	$\text{RMS} = \sqrt{\frac{1}{(N_2 - N_1)} \sum_{i=N_1}^{N_2} (V_i)^2}$	

4.4 | Analyzing a Record

To open a saved measurement file, go to “Drive” from the main navigation bar.

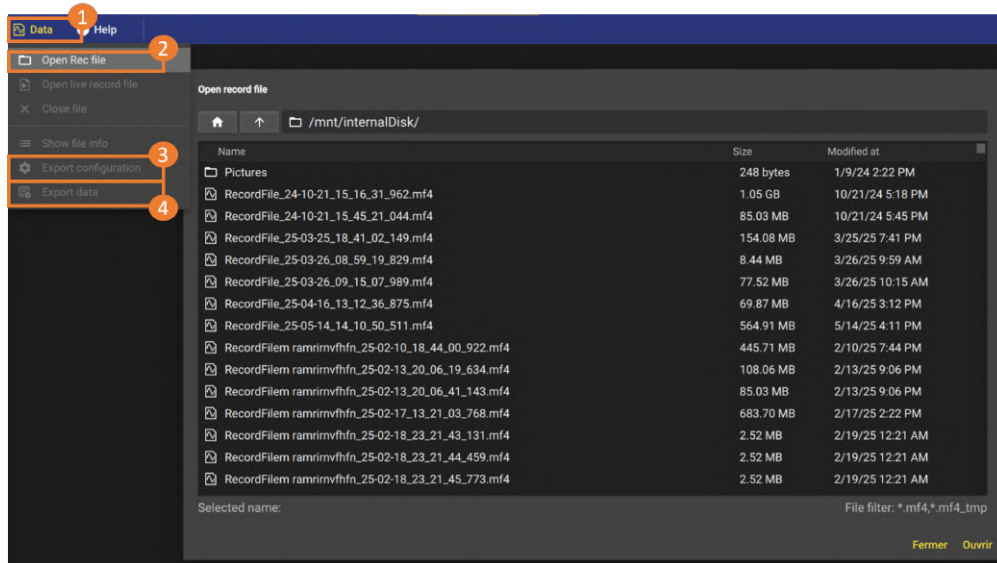

Figure 4.12: Saved file list

By pressing “Data” (1), you can :

- Access all recorded files by pressing “Open record” (2). The list of all recordings on the DAS internal disk opens, select the file you wish to read and press “Open”.
- Export the configuration (3) used to make the recording.
- Display data from a saved file (4): general information, channel description, markers, modification history.

4.5 | Event marker

4.5.1 Using markers

Markers can only be added during a recording. They are used to indicate a particular event which may influence the measurements in progress, such as the opening of a valve or the start-up of a motor.

To add a marker, simply press the “Add marker” button during recording. You can then either create a new marker (1) by clicking on the , or select an existing marker from the drop-down list (2).

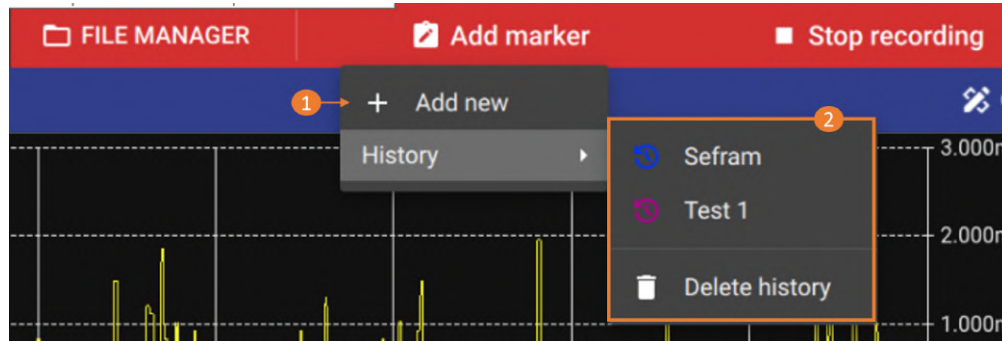

Figure 4.13: Event marker



The marker will be inserted into the timeline exactly when you press the “Add marker” button.

4.5.2 Viewing markers in the file viewer

Once the recording has been completed and opened in the file viewer, all markers are displayed in the timeline (1). This makes it easy to navigate and zoom within the recording, while keeping an overview of important events.

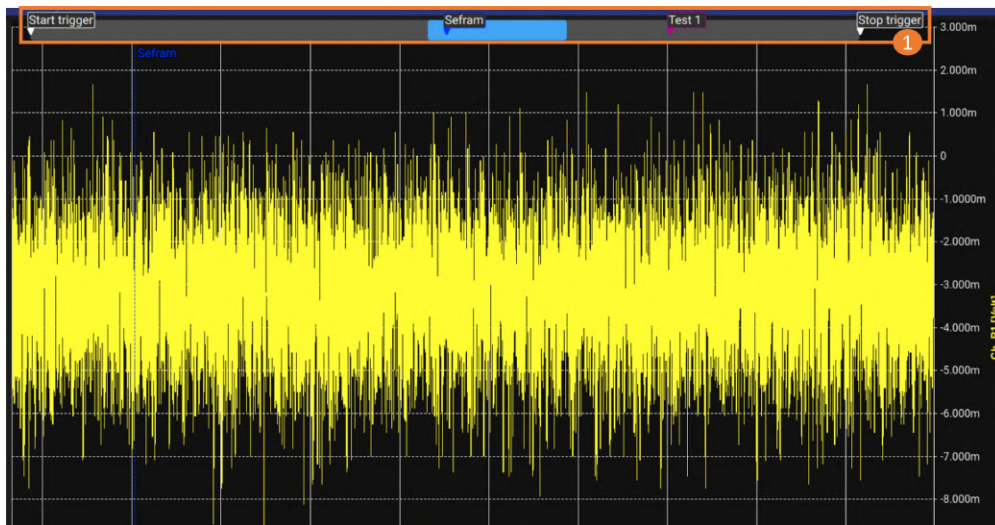

Figure 4.14: Mark event in file

By selecting a marker, you can access its general information. Viewing options are also available to adjust its display on screen: you can center the marker or move it to the left or right as required.

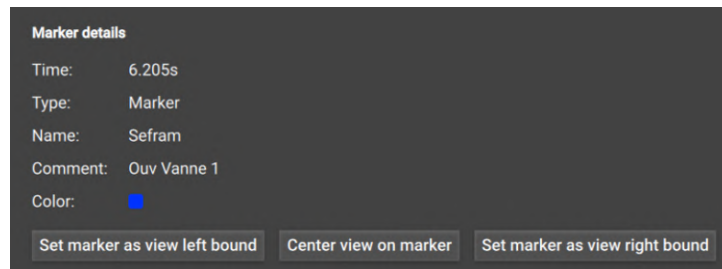

Figure 4.15: Event marker display management

Simultaneous recordings

The viewer displays markers representing the triggers for other files. Clicking on them allows you to open the corresponding file (1).

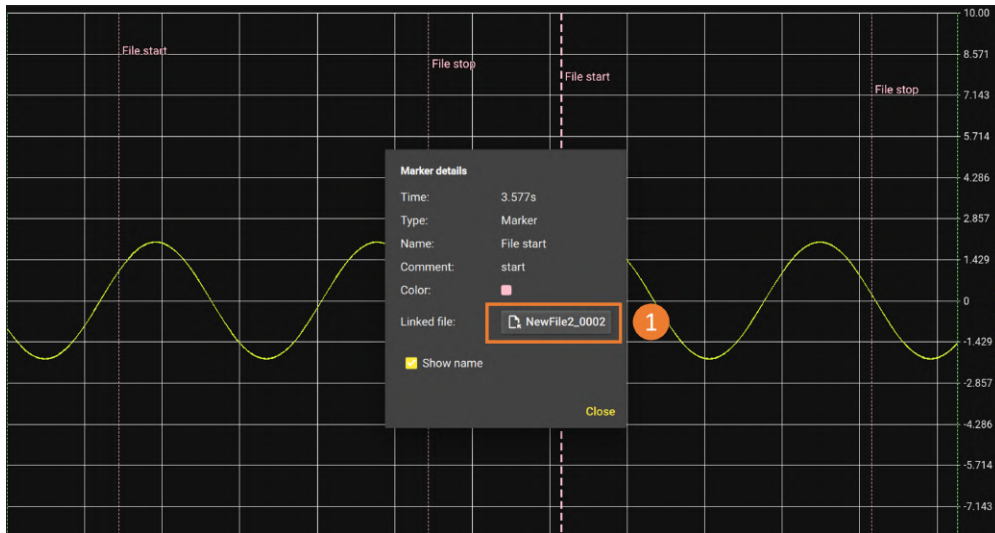

Figure 4.16: Marker of another recording trigger

In the properties of the current file, you can find a table of all markers under the “markers” tab (2).

The figure shows the 'MDF4 File Info' window with the 'Markers' tab selected. The table below lists the markers:

Time	Type	Name	Comment	Color	File
0, Wednesday, 26 November 2025 14:31:21 CET	Start Recording Trigger	Start trigger	Start trigger event: FORCE_TRIGGER	Green	
720ms, Wednesday, 26 November 2025 14:31:21 CET	Marker	File start	start	Red	NewFile2_0001
2.72s, Wednesday, 26 November 2025 14:31:23 CET	Marker	File stop	stop	Red	NewFile2_0001
3.58s, Wednesday, 26 November 2025 14:31:24 CET	Marker	File start	start	Red	NewFile2_0002
5.58s, Wednesday, 26 November 2025 14:31:26 CET	Marker	File stop	stop	Red	NewFile2_0002
6.13s, Wednesday, 26 November 2025 14:31:27 CET	Stop Recording Trigger	Stop trigger	Stop trigger event: MANUAL_STOP	Green	

Figure 4.17: Marker table showing simultaneous recordings

4.6 | Exporting a record file

In the “DATA” menu, click on the “Export data” button (1)

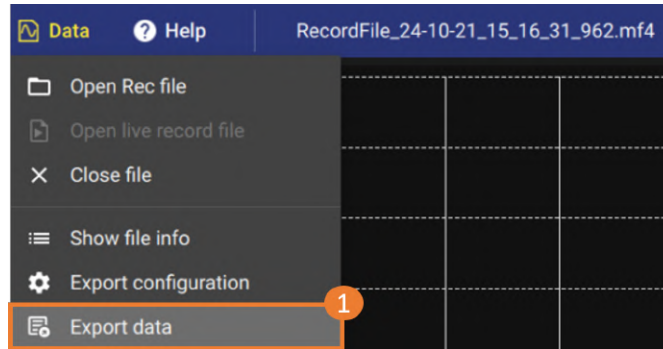

Figure 4.18: Select file for export

Measurement selection :

Measurements in the file are grouped by recording frequency (1). Select the measurements to be exported from the drop-down list (2) by ticking the associated box (3). Check the box corresponding to a frequency group to export all associated measurements.



Figure 4.19: Selecting data for export

Confirm your selection by pressing the “Next” button.

Recording period:

This interface allows you to shorten a recording by modifying the start and/or end date. The time bar displayed in blue represents the selected portion of time. By default, the entire duration of the recording is selected. To modify the recording start date, move the left cursor **(2)**. To change the recording end date, move the cursor to the right. The selected start and end dates, together with the corresponding duration, are displayed below the time bar. By default, dates are displayed relative to the recording start date. To display dates absolutely in the format YYYY/MM/DD HH:MM:SS:ms, uncheck the “Time relative” box at the bottom of the interface.

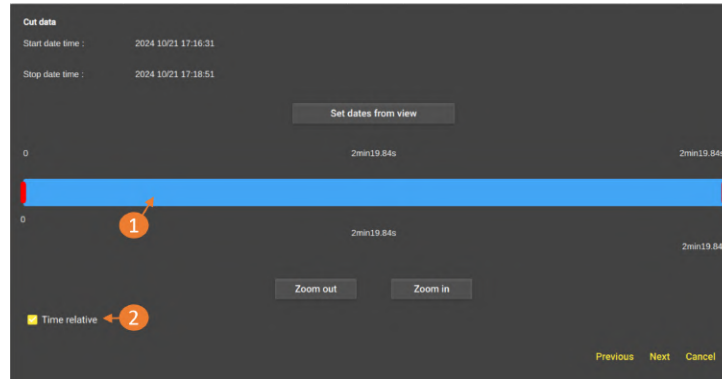

Figure 4.20: Select export period



You can click on the start or end date to modify it from a dedicated interface.

To select a small portion of the recording, it may be necessary to zoom in on the time bar. Click on the ZOOM FORWARD button to zoom in on the selected portion of time. The time bar occupies all available space, and the selectable start and end dates at the top of the time bar are updated with the selected start and end dates.



The **SET DATES FROM VIEW** button is used to select the start and end dates corresponding to the portion of time displayed in the PLAYER tab.

Resampling :

The export process offers the option of resampling the data. All data will be resampled at the specified frequency. The resampling frequency can be defined in two different ways:

- Resample data at a new frequency: the user defines the resampling frequency directly. The maximum frequency is 1MHz. The minimum frequency is set so that the file contains a minimum of 100 samples. If the original file size is less than 100 samples, it will not be possible to downsample the data.
- Resample data according to the time base of a measurement: the resampling frequency will be that of the group associated with the measurement.

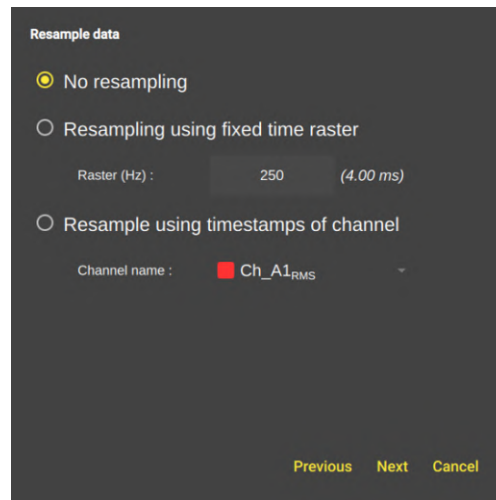

Figure 4.21: Resampling

Conversion :

Select output file format:

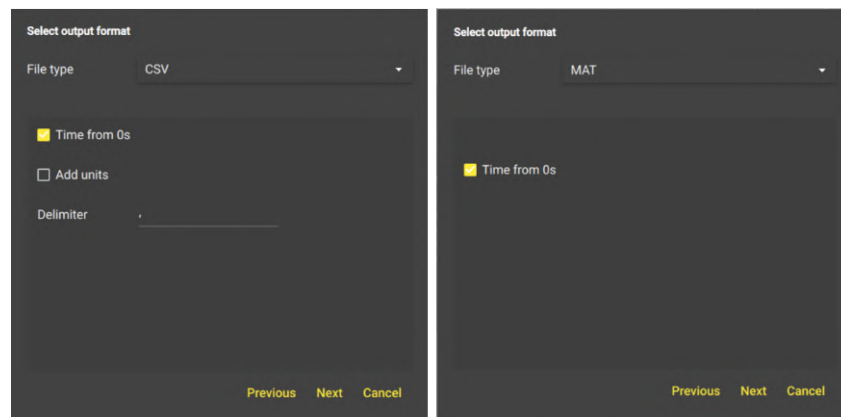

Figure 4.22: Selection of format

- MDF format: Default format for use with DASPRO software
- CSV format: maximum file size limited to 5M samples.
 - Absolute dates: display time absolutely or relative to start of recording.
 - Add units: add a line under the measurement name containing the units.
 - Delimiter: character used to delimit file columns.
- MAT format:
 - Absolute dates : display time absolutely or relative to the start of the record

4.7 | File transfer

4.7.1 File retrieval via USB key

Plug a USB key into one of the device's ports. To retrieve a file from the device's hard disk and transfer it to your computer, go to "File Manager" from the main navigation bar. Press "DISK" to access the entire contents of the device's internal memory.

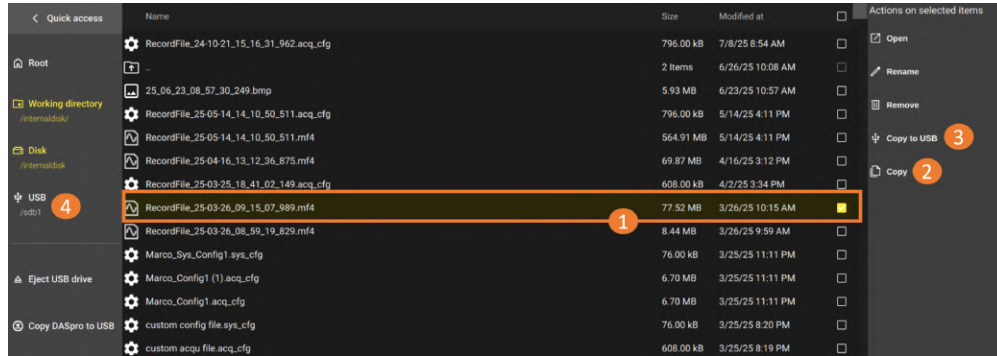

Figure 4.23: Copy a file to a USB key

1. Select the desired file (1)
2. Press "COPY" (2) to copy the file to a manually selected folder on the disc or USB stick. Go to USB (4). Press "Paste" on the selected folder to copy the file.
3. Press "COPY TO USB" (3) to copy the file to the root of the connected USB stick.



Press "EJECT USB DRIVE" before removing the key.

4.7.2 File transfer via FTP protocol

Connect the device to a computer network via the Ethernet port or Wi-Fi option. For further information on network configuration, please refer to the section : [Remote control](#).

From your remote computer, open a file explorer. Enter "ftp://" followed by the device's IP address to access the files.



The connection uses the port21.

- User : «normal»
- Password : «normal»

4.7.3 File transfer via NAS

Connect the device to a computer network via the Ethernet port or Wi-Fi option. For more information on network configuration, go to the section : [Remote control](#) and then activate the NAS.

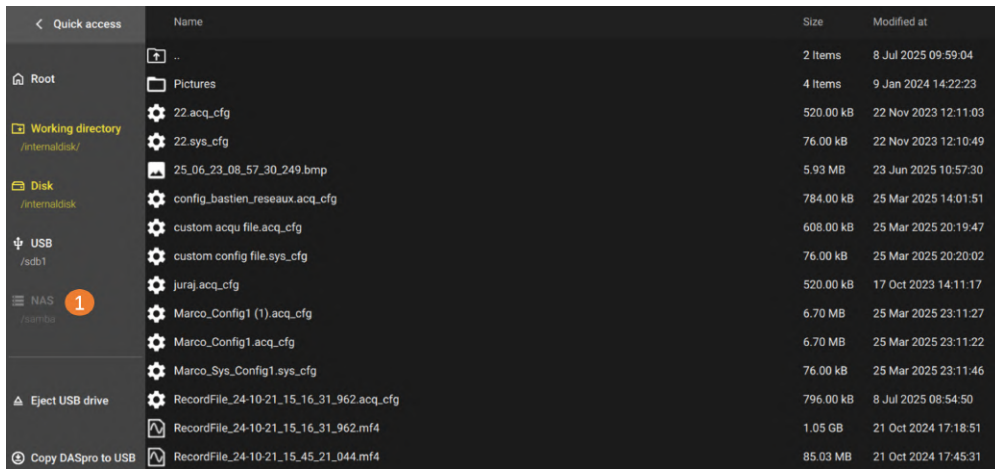

Figure 4.24: Copy a file to the NAS

When the NAS is active, its icon becomes visible (1). To transfer a file to the NAS in manual mode, the user simply needs to copy the desired file (e.g. .mf4 file, screenshot or configuration file), then paste it into the dedicated folder. The file will be automatically transferred to the NAS.

Chapter 5

Advanced features

5.1 | Units library

The units of measurement are managed from a database accessible from “*Configuration*” > “*Channels*” > “*Units library*”

Name ↑	Symbol	Quantity	Edit	Delete
		Scalar quantity	ⓘ	🗑️
Ampere	A	Current	ⓘ	🗑️
Bar	Bar	Pressure	ⓘ	🗑️
Becquerel	Bq	Radioactivity	ⓘ	🗑️
Candela	cd	Luminous intensity	ⓘ	🗑️

Figure 5.1: Unit libraries

By default, most of the most commonly used units of measurement are already integrated into the device. To add a unit, press “Create unit” **(1)**. They can be modified at any time from the “Edit” column.

In the example below, we’ll add the mass unit “pound” :

Unit information

Unit name: Pound

Symbol: lb

Physical quantity: Mass (Base unit: Kilogram)

Conversion function: Linear (y = ax)

Base unit Kilogram = 0,45359237 * New unit Pound

New unit pound = 2,20462262184 * Base unit Kilogram

Close

Figure 5.2: Creation of a "pound" unit

Define the name of the unit **(1)** and the associated symbol **(2)**. Choose the corresponding physical quantity from the drop-down list **(3)**. In our case, the pound is a mass. Finally, define the conversion function **(4)**.



The conversion function is a calculation applied to the reference unit of the international system, which in the case of mass is the kg.

- Identical: ratio of 1 to 1
- Linear: application of a coefficient to the reference unit. In our case, 1 pound is equal to 0.453592 kg.
- Affine: application of an affine function to the reference unit, such as $ax + b$.



Before adding and configuring a sensor in the device, make sure that the unit of the physical quantity you want to measure is present in the unit library.

5.2 | Sensors library

Each measurement is associated with a sensor. To access the sensor library, go to “*Configuration*” > “*Channels*” > “*Sensor libraries*”. A table listing all sensors and their parameters is shown on this page.

Name	Manufacturer	Measure	Unit	Type	Min value	Max value	Configure	Favorite ↓	Delete
Pression 0 10 V	Sefram	Pressure	Bar	Other		110.0			
Shunt_100	Sefram	Current	Ampere	Shunt					
Shunt_10	Sefram	Current	Ampere	Shunt					
Thermocouple_K		Temperature	Celsius	Thermocouple	-270.0	1.372k			
Pt100		Temperature	Celsius	PTx	-200.0	850.0			
Pt1000		Temperature	Celsius	PTx	-200.0	850.0			
Thermocouple_J		Temperature	Celsius	Thermocouple	-210.0	1.2k			
Pressure_PS100E02	Omron	Pressure	Pascal	Other		200k			

Figure 5.3: Sensors library table

The system integrates a filtering function (1) allowing the list of sensors to be refined according to their name or that of the manufacturer. The display of information in the table can also be organized using the sorting function (2) in order to classify the data according to your needs. The Favorites option (5) allows the creation of a personalized list grouping the most frequently used sensors for quick and simplified access.

To modify the parameters of an existing sensor, press (3) or (4).

5.3 | Sensor configuration

5.3.1 Creation of a new sensor

The default page for creating a new sensor is displayed after pressing the "Create a sensor" button.

FIGURE 5.4 : Create sensor

1. Selection of the name of the created sensor and general sensor information. Selection of the sensor type (4–20 mA, Shunt, Clamp ammeter, Other) as well as its interface if the selected type is "Other" (0–10 V, Analog voltage, Resistance, Counter, Frequency, etc.). The unit of measurement associated with the displayed value (measurand) can also be modified. This configuration is performed in the last box entitled "Physical measurement unit".
2. This window allows the definition of the parameters required for the configuration of the measurements displayed by the device. The user can select the type of conversion function used to transform the sensor signal into a usable physical value. Two types of functions are available : "Linear" and "Affine". These functions are essential to correctly adapt the relationship between the electrical signal delivered by the sensor and the physical unit that the device must display.
 - (a) The "Sensor Interface" corresponds to the electrical signal provided by the sensor or the transmitter. It is generally a standardized voltage or current range, for example 0 to 10 V, 0 to 5 V, or 4 to 20 mA.
 - (b) The physical measurement represents the actual quantity measured by the sensor (pressure, level, speed, etc.).
3. Sensor measuring range and sensor response time. Enter the values indicated on the sensor technical data sheet.
4. Sensor manufacturer name.
5. General description of the sensor. This field allows entry of information related to the manufacturer or a detailed description of the sensor (up to 1000 characters).
6. Option selection to add to the favorites list.



The interface window adapts according to the parameters selected during the creation of the sensor.

5.3.2 Configuration of a sensor with function : Linear

The Linear function allows the adjustment of a sensor's output value to the measured physical quantity by applying a fixed conversion coefficient. The value provided by the sensor is therefore converted in order to directly display the corresponding physical value on the DAS acquisition system.

- The sensor output value is represented in blue.
- The measured physical quantity value is represented in green.

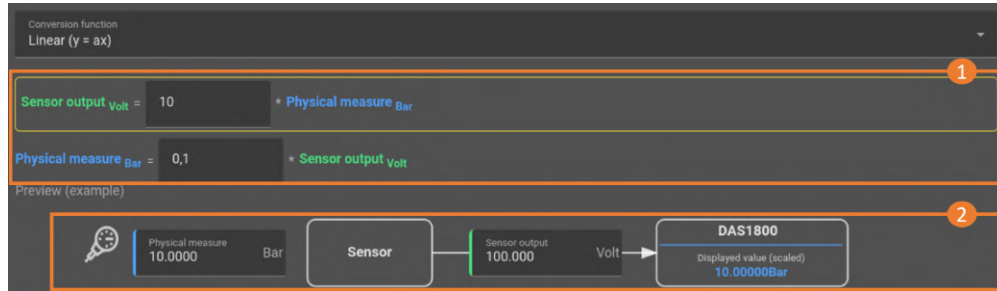

FIGURE 5.5 : Programming of the linear function

1. Coefficient setting : The conversion coefficient is set directly in this box. Two parameterization methods are possible :
 - (a) from the sensor output The sensor output value (upper line) is used as the reference. The system then applies the coefficient in order to calculate the corresponding physical value.
 - (b) from the physical value The value of the physical quantity is entered directly. The system then determines the corresponding relationship with the sensor output by applying the linear coefficient.
2. Conversion example : An illustrative example displays the measurement relationship between the sensor output and the value displayed on the DAS screen. This example is automatically updated when the linear coefficient is modified. It is also possible to modify the example values in order to test different measurement cases, particularly the minimum and maximum values that can be provided by the sensor.

5.3.3 Configuration of a sensor with function : Affine

The Affine function allows the output value of a sensor to be adjusted so that it precisely corresponds to the measured physical quantity. To achieve this, a conversion coefficient and a fixed intercept are applied to the value provided by the sensor. The value provided by the sensor is thus converted in order to directly display the corresponding physical value on the DAS data acquisition system. In order to best adapt to different configurations and to the requirements of your process, two configuration methods are available :

Adjustment mode : 2 points

The 2-point function allows a correspondence to be defined between a measured physical quantity and the output signal of a sensor. This method, presented in graphical form, facilitates the creation of a relationship of type $X1 - X2 / Y1 - Y2$.

Function configuration : To configure this function, start by entering the full-scale values of your sensor.

- X1 (3) : corresponds to the lower value of the measured physical quantity.
- X2 (4) : corresponds to the upper value of the measured physical quantity.

These two values must always represent the full measurement range of the sensor. Then define the corresponding values for the output signal :

- Y1 (1) : value of the sensor output signal when the physical quantity is equal to X1 (minimum value).
- Y2 (2) : value of the sensor output signal when the physical quantity is equal to X2 (maximum value).

A conversion example (5) is available and adjustable in the interface. It allows verification of the parameterization consistency and visualization of the correspondence between the physical quantity and the output signal.

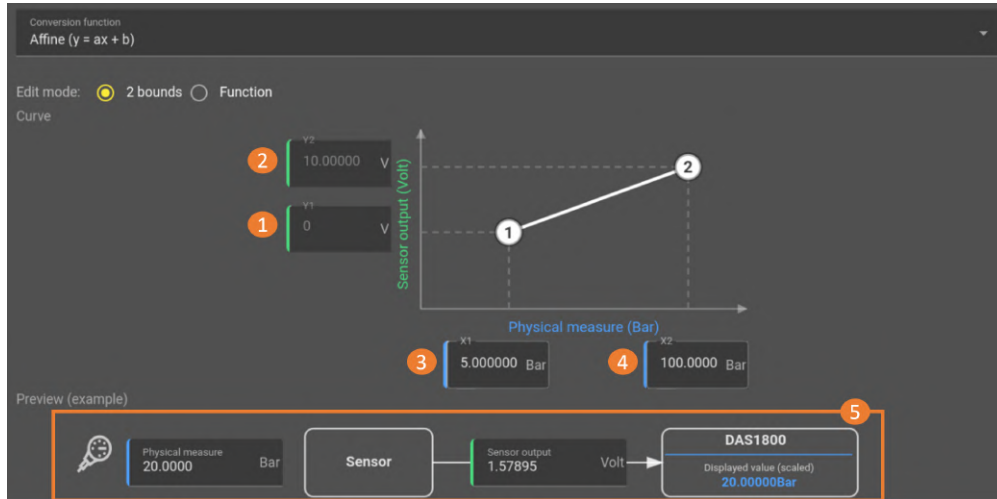

FIGURE 5.6 : Programming of the Affine Function – Two-Point Method



Example of Application : Let us take the example of a pressure sensor with the following specifications :

- Measurement range : 5 to 100 bar
- Output signal : 0 to 10 V

In this case :

- The physical quantity (X) corresponds to the pressure in bar.
- The output signal (Y) corresponds to the sensor's output voltage (0 to 10 V).

The configuration will then allow establishing the relationship between the measured pressure and the voltage provided by the sensor.

Adjustment Mode : Functions

The “Function” type is similar to the “Linear” mode. It allows adjusting the output value of a sensor to the measured physical quantity by applying a conversion coefficient and a constant (intercept). The value provided by the sensor is thus converted in order to directly display the corresponding physical value on the DAS acquisition system.

Configuration is performed by entering the values into the line equations (1) or (2). These two equations are linked and automatically update according to the selected configuration. Start by entering the coefficient (**a**) and the intercept (**b**) in the corresponding fields. These parameters are generally specified in the sensor's datasheet.

The screenshot shows the configuration interface for an Affine function. At the top, a dropdown menu is set to "Affine (y = ax + b)". Below it, the "Edit mode" is set to "Function". Two equations are provided for configuration:

- $\text{Sensor output}_{\text{Volt}} = 10 + \text{Physical measure}_{\text{Bar}} + 100$ (Coefficient **a**, Intercept **b**)
- $\text{Physical measure}_{\text{Bar}} = 0.1 + \text{Sensor output}_{\text{Volt}} + -10$ (Coefficient **a**, Intercept **b**)

A "Preview (example)" section shows a flow diagram: a physical measurement of 20.0000 Bar is input to a "Sensor", which outputs 300.000 Volt. This output is then processed by the "DAS1800" system to display a scaled value of 20.00000Bar.

FIGURE 5.7 : Programming of the Affine function – function method



For a simpler and more intuitive configuration, it is recommended to use the two-point method.

Example (3) illustrates the relationship between the actual physical measurement and the value read by the DAS system.

5.4 | The different types of digital filter

The user can choose between 4 different types of digital filters:

5.4.1 Low-pass filter

The low-pass filter is a device that exhibits a relatively constant frequency response (fixed gain) at low frequencies and a decreasing gain at frequencies above the cut-off frequency. The rate of decay depends on the order of the filter. The IIR filter implemented in the acquisition card channel is a 4th-order filter (signal attenuation of -80 dB per decade).

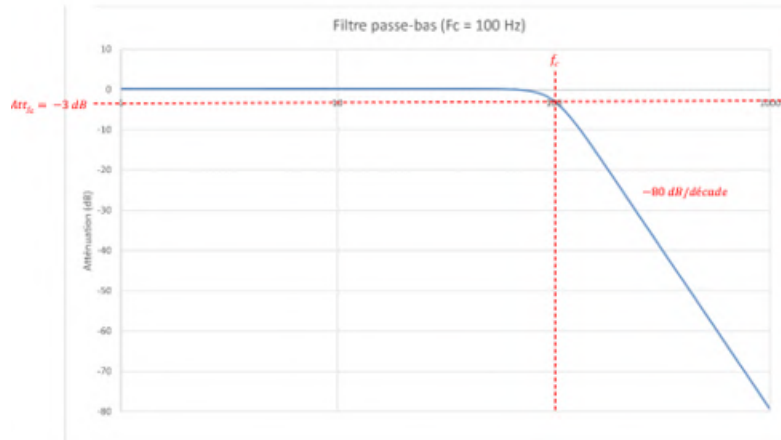

5.4.2 High pass

The high-pass filter is a device that shows increasing gain at frequencies below the cut-off frequency and a relatively constant frequency response (fixed gain) at high frequencies. The rate of increase depends on the order of the filter. The IIR filter implemented in the acquisition card channel is a 4th-order filter (signal attenuation of 80 dB per decade).

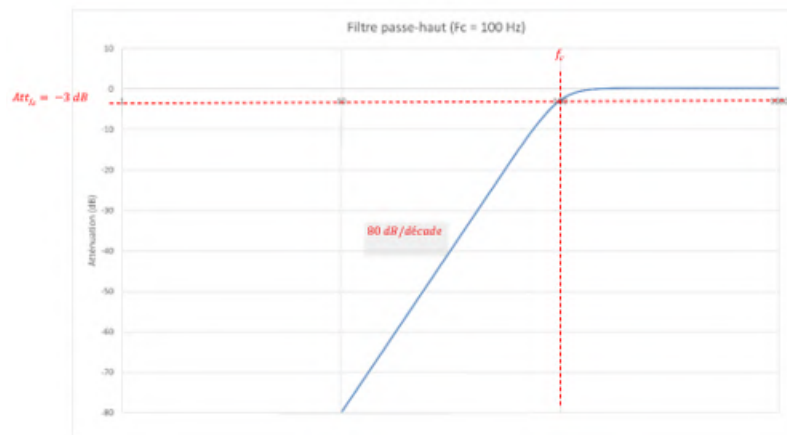

5.4.3 Bandpass

The bandpass filter is a device that demonstrates a relatively constant gain in the passband (band of frequencies between a low cutoff frequency and a high cutoff frequency), increasing gain at frequencies below the low cutoff frequency (40 dB / decade) and decreasing gain at frequencies above the high cutoff frequency (40 dB / decade). The high and low cut-off frequencies are defined by the user using the two parameters center frequency and bandwidth.

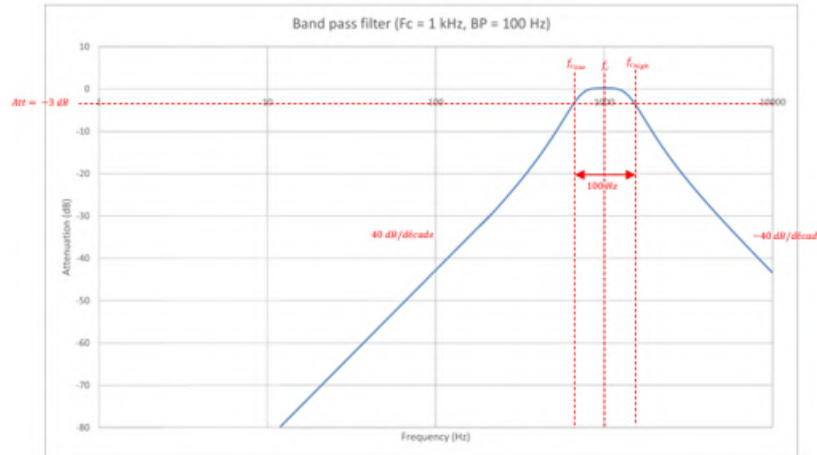

5.4.4 Tape cutter

The tape cutter filter is a device that provides relatively constant gain in the passband (frequency band below a low cutoff frequency and frequency band above a high cutoff frequency). The signal is attenuated by 40 dB per decade in the cut-off band.

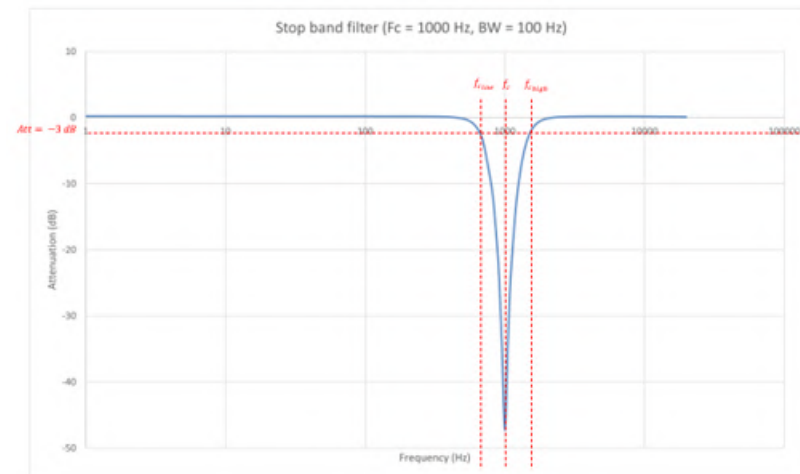

5.4.5 Filter prototype

The filtering performed is infinite impulse response. An infinite impulse response filter (IIR filter) is a type of electronic filter characterized by a response based on the values of the input signal and previous values of the same response. It is so named because, in the majority of cases, the impulse response of this type of filter is theoretically infinite in duration.

$$y[n] = \sum_{k=0}^N b_k \times x[n - k] - \sum_{k=1}^M a_k \times y[n - k]$$

There are 3 main characteristics:

- Butterworth
- Chebyshev
- Bessel

Butterworth

The Butterworth characteristic is probably the most commonly used for signal filtering. This characteristic is said to be "the flattest in frequency". The parameters of this type of filter are arranged so as to achieve the most constant gain possible in the passband and -3 dB attenuation at the cutoff frequency, whatever the filter order. The index response of the Butterworth filter shows an overshoot.

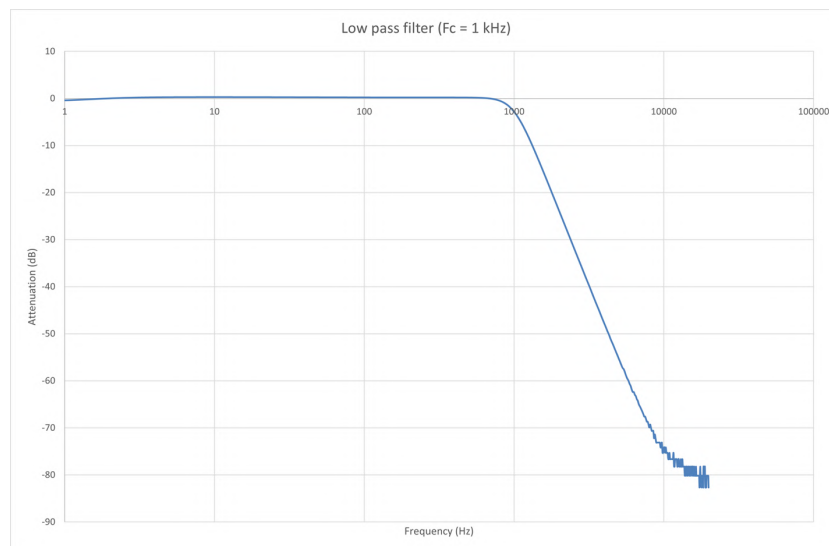

Figure 5.8: Butterworth low-pass filter: Bode diagram

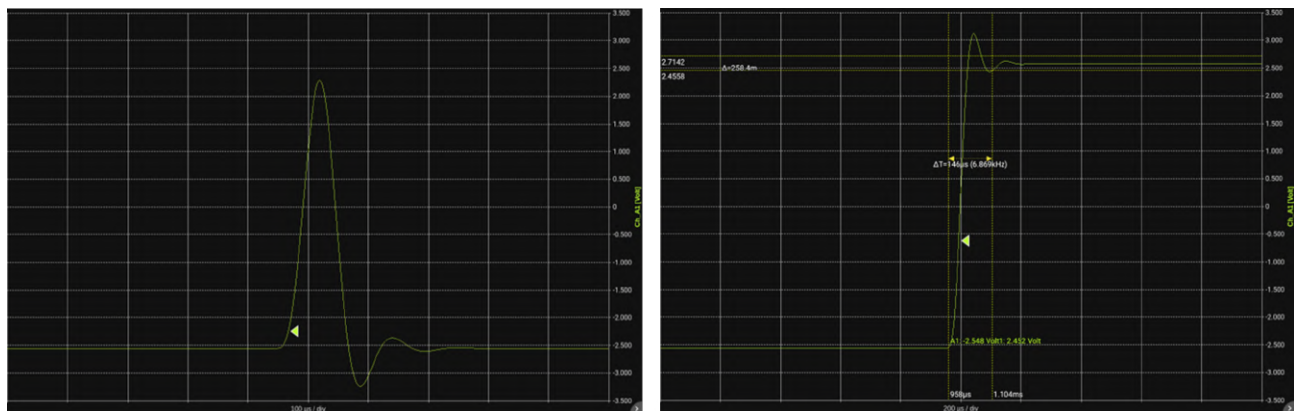

Figure 5.9: Butterworth low-pass filter: Impulse and step response

Chebyshev

In contrast to the Butterworth characteristic, the Chebyshev characteristic presents a ripple in the passband. However, it offers better attenuation around the cut-off frequency. The passband ripple is fixed at 0.1 dB. This filter is widely used when ripple is not a problem. As with the Butterworth filter, there is an overshoot in the index response of the Butterworth filter.

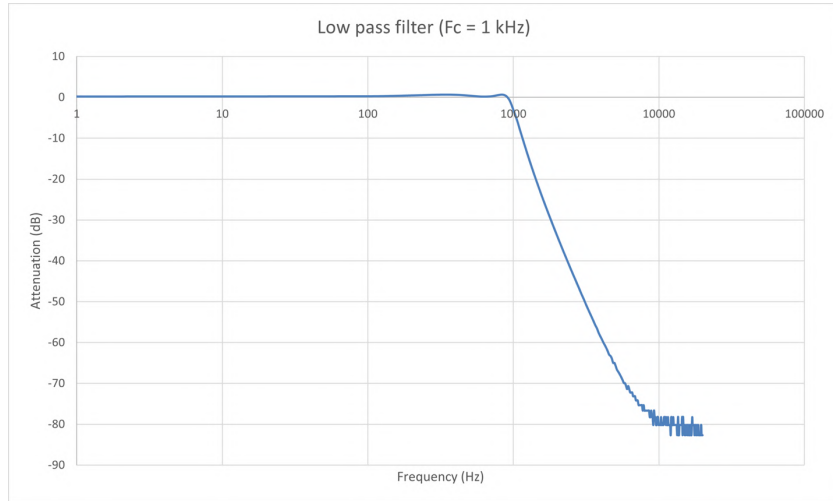

Figure 5.10: Chebyshev low-pass filter: Bode diagram

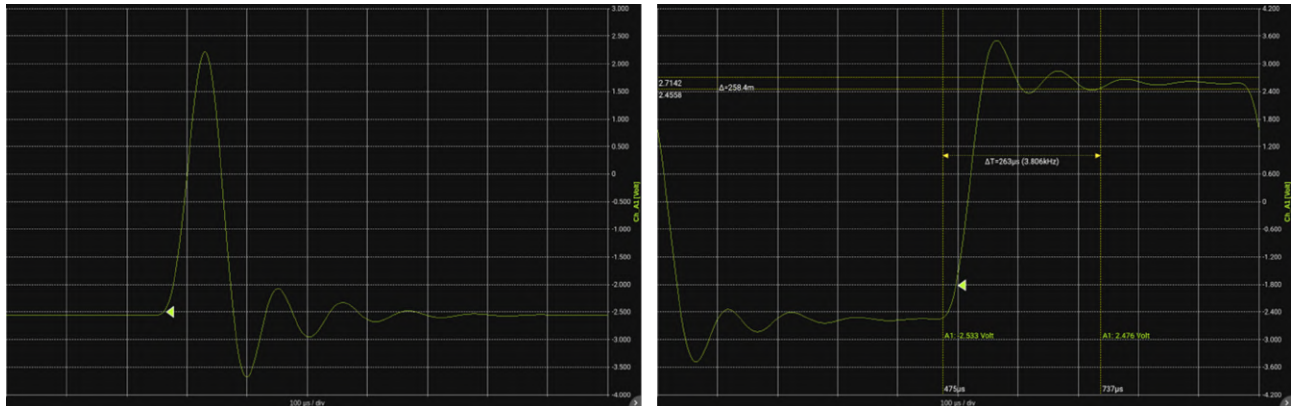

Figure 5.11: Chebyshev low-pass filter: Impulse and step response

Bessel

The Bessel filter, also known as the Thompson filter, is a filter whose main characteristic is to offer a constant bandwidth delay. In concrete terms, this means that all pure, in-band frequencies pass through it in exactly the same time. The Bessel filter therefore minimizes the distortion that a complex signal undergoes during a filtering operation.

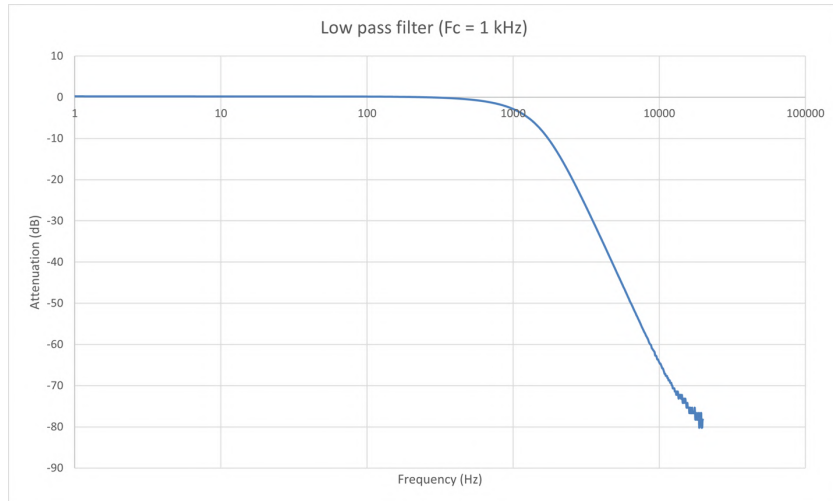

Figure 5.12: Bessel low-pass filter: Bode diagram

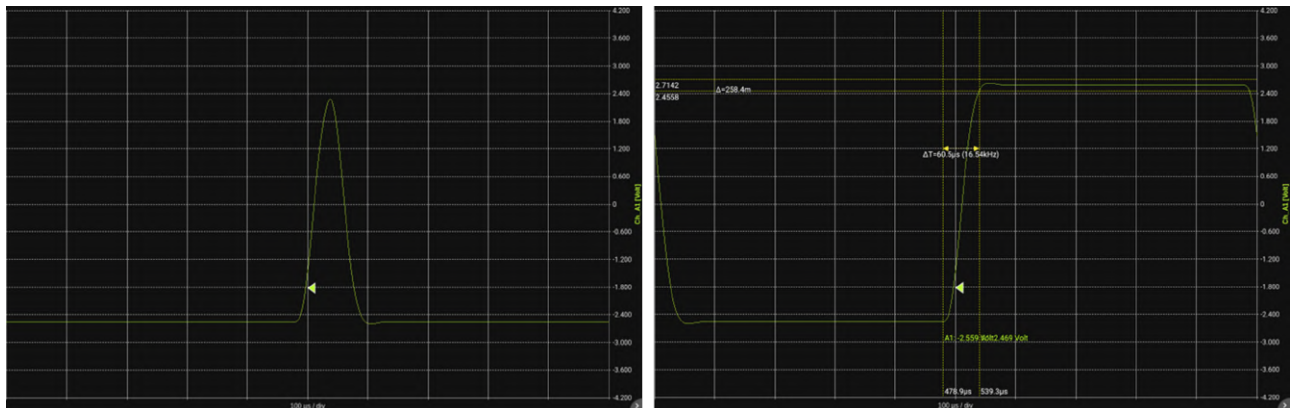

Figure 5.13: Bessel low-pass filter: Impulse and step response

Comparison of the 3 filter types Butterworth / Chebyshev / Bessel

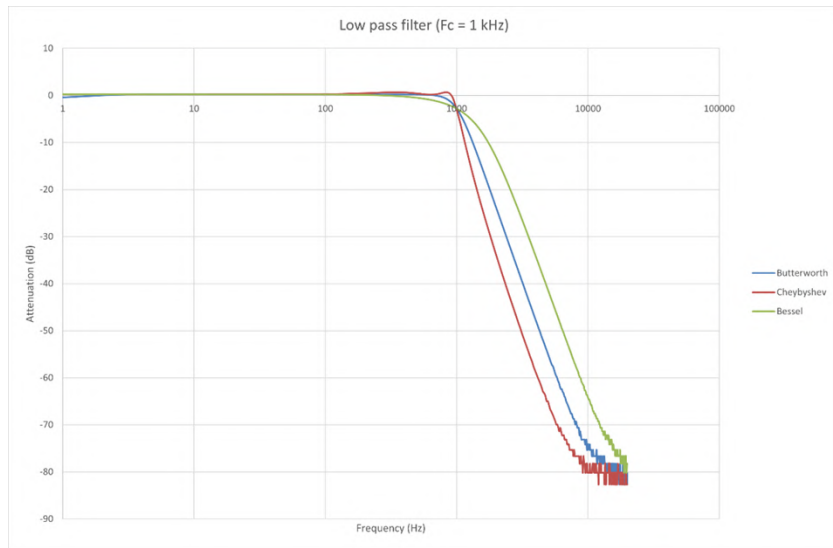

Figure 5.14: Filter comparison: Bode diagram

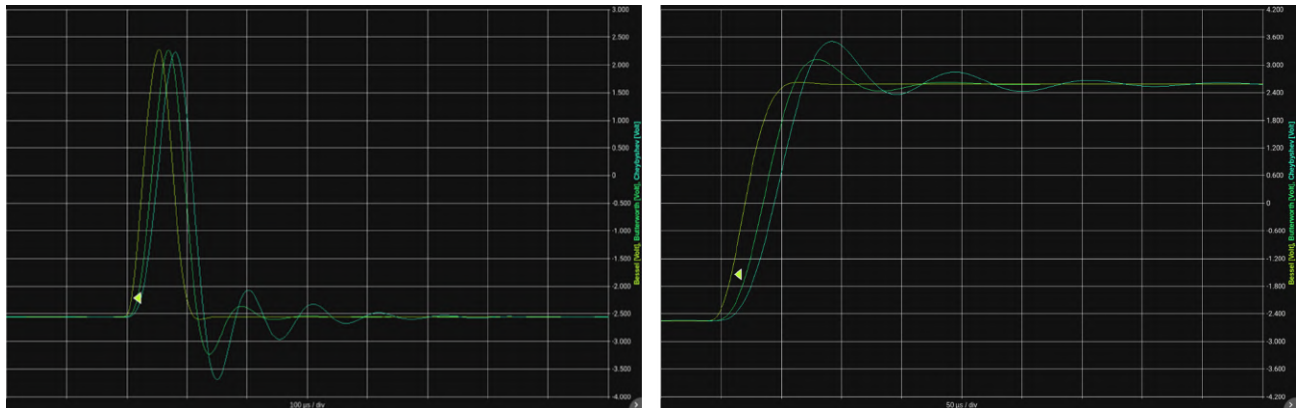
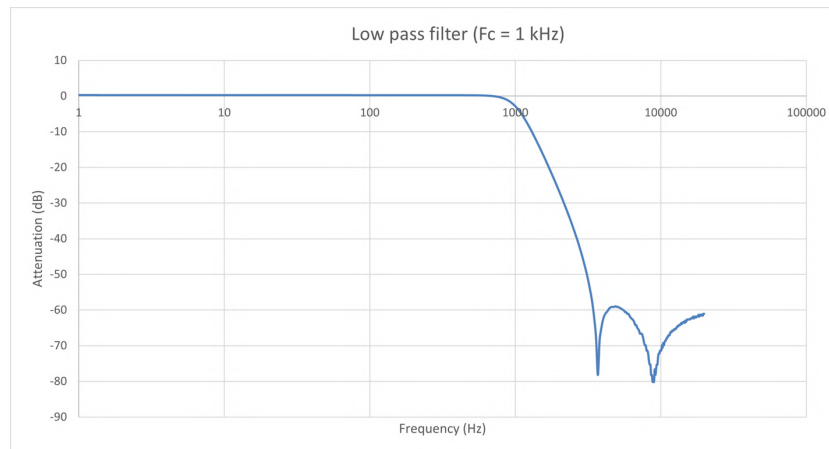

Figure 5.15: Filter comparison: Impulse response and step response

Chebyshev reverse

The Chebyshev type 2 filter, also known as inverse Chebyshev, has monotonic passband attenuation, like the Butterworth filter, and ripples in the stopband. This filter has a better group delay, which means less distortion of complex signals.



Elliptical trainer

An elliptical filter is a type of filter that has an equiripple frequency response in both the passband and stopband. This means that the amplitude variation in these bands is constant and equal to a specified value. An elliptical filter also has the steepest transition between passband and stopband, which means it can achieve the highest selectivity for a given filter order.

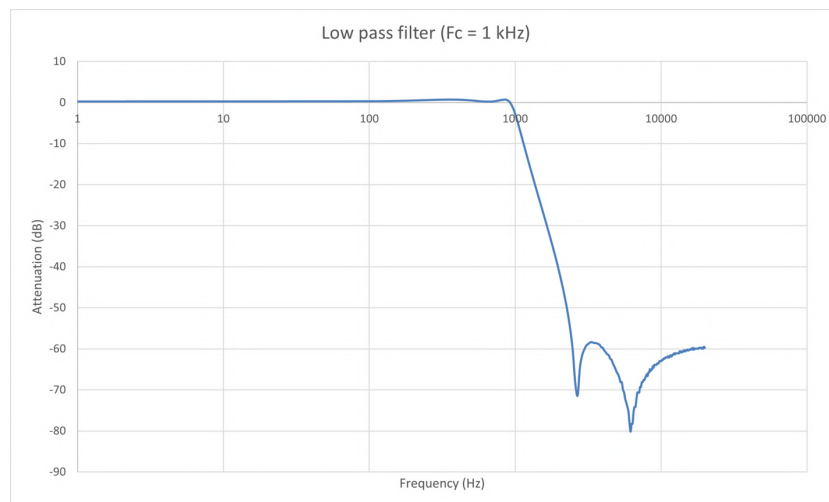

Papoulis

The Papoulis filter provides a compromise between the Butterworth filter, which is monotonic but has slower attenuation, and the Chebyshev filter, which has faster attenuation but has ripple in the passband or stopband.

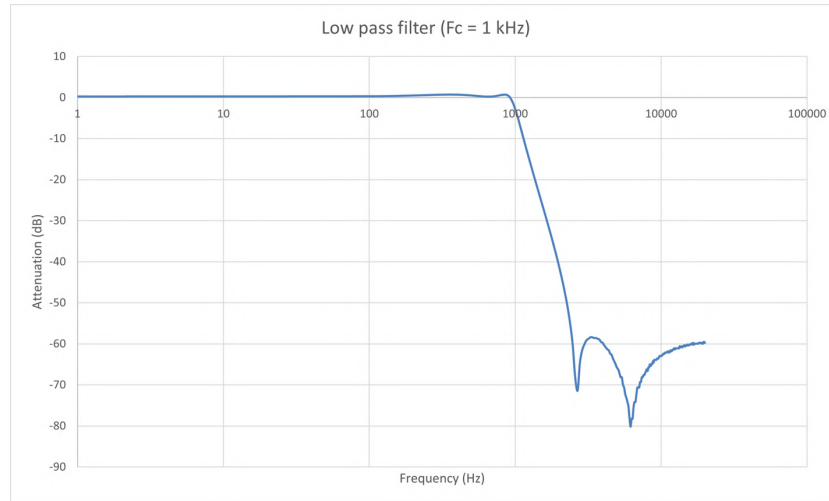

5.5 | Cold welding compensation

When two wires composed of different metals are connected at their ends and one of them is heated, direct current flows through the circuit. This is the thermoelectric effect. Circuit cut and heating the junction of the two different metals A and B, a voltage e_{AB} appears. It depends on the temperature of the junction and the composition of the two metals. All dissimilar metals have this effect.

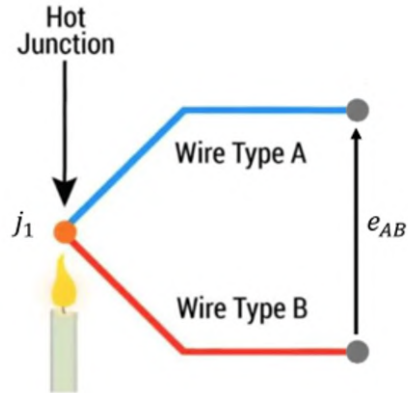

By connecting a Copper/Constantan thermocouple to the copper terminals of a voltmeter, we created two new metal junctions:

- J3 : copper-to-copper junction that does not create thermoelectric voltage
- J2 : junction made up of two different metals (Copper/Constantan) which generates a thermoelectric voltage (V_2) and which comes in opposition to the voltage V_1 which one wishes to measure

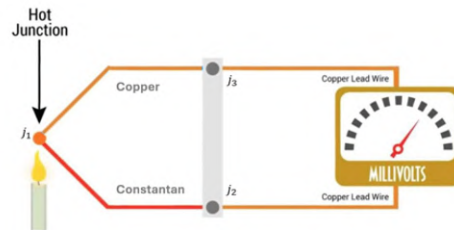

The resulting voltage measured by the voltmeter is equal to $V_1 - V_2$, that is, it is proportional to the temperature difference between J_1 and J_2 . J_2 junction is called reference junction or cold weld. By measuring the temperature of the reference junction using a temperature sensor, it is possible to deduce the temperature of the hot weld.

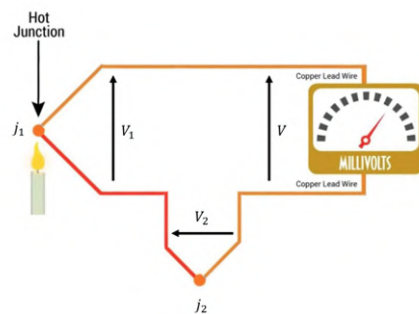

The DAS1800 interface offers different methods of cold junction compensation : Internal, External or Manual.

No correction

No cold welding correction is applied. The temperature returned to the user is the temperature of the thermocouple table associated with the measured voltage. This option can be used if the user wants to measure the temperature difference obtained by two different thermocouples via the use of scripts (calculations between channels). The user is then free from the cold solder compensation error.

Internal compensation

The cold weld temperature is measured by the sensor inside the acquisition board. The correction is then calculated as follows:

- Measure cold weld temperature T_{REF}
- Convert T_{REF} in equivalent junction voltage V_{REF}
- Measure the voltage V and add V_{REF} to get V_1
- Convert V_1 temperature T_{J1}

External compensation

To gain precision, the cold weld can be moved away from the track. By placing the cold weld in an isotherm case, the cold weld is less influenced by the environment and it becomes easier to accurately measure its temperature. The user must then specify on which channel the sensor measuring the temperature of the cold weld is wired. The correction is then calculated as for internal compensation.

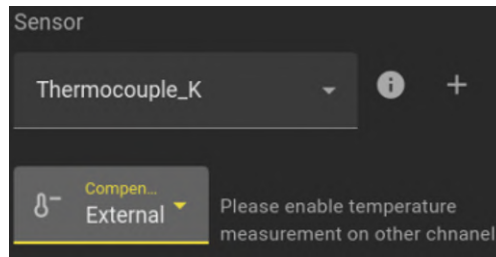

Manual compensation

The user directly specifies the temperature of the cold weld.

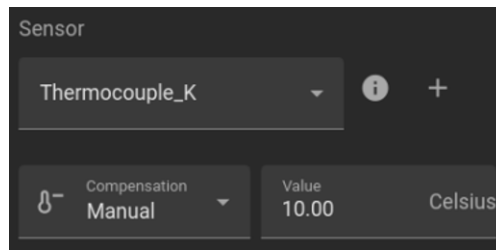

5.6 | Calibration

Adjustment of universal boards and thermocouple cold junction is managed from a database accessible from “*Configuration*” > “*Channels*” > “*Adjustment*”.

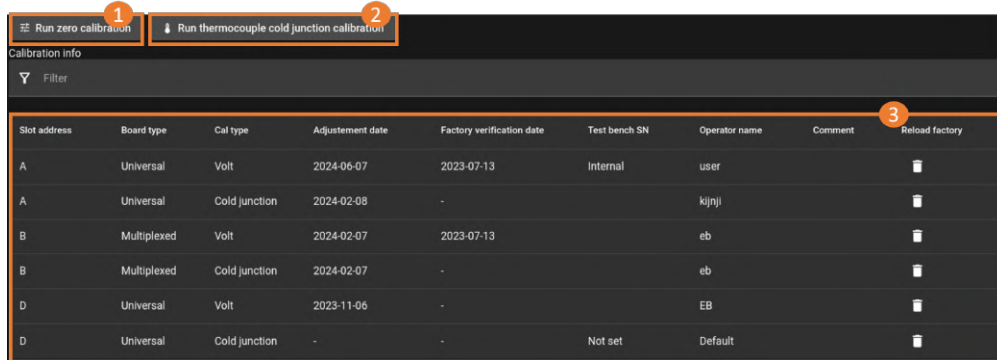

Slot address	Board type	Cal type	Adjustment date	Factory verification date	Test bench SN	Operator name	Comment	Reload factory
A	Universal	Volt	2024-06-07	2023-07-13	Internal	user		
A	Universal	Cold junction	2024-02-08	-		kijnji		
B	Multiplexed	Volt	2024-02-07	2023-07-13		eb		
B	Multiplexed	Cold junction	2024-02-07	-		eb		
D	Universal	Volt	2023-11-06	-		EB		
D	Universal	Cold junction	-	-	Not set	Default		

Figure 5.16: Calibration

1. Start 0V trimming on a universal board by following the video tutorial included in the procedure.
2. Tab to start cold junction measurement adjustment for one or more channels on a universal or multiplexed board, following a video tutorial included in the procedure.



Possibility of adjusting a card channel by channel.

3. History of adjusted modules and channels



The procedures are explained in detail in the corresponding chapter: [Procedure and Maintenance](#).

5.7 | Remote control



To use the remote control functions, the device must be connected to a network. Please refer to the section: [Network settings](#) for further information on configuration.

5.7.1 Web server

The system incorporates a web server function, enabling a connection to be established via the Internet from a web browser. To do this, enter the IP address in the browser address bar (1). You'll find the device's IP address in the "Status" section of the home menu (2).

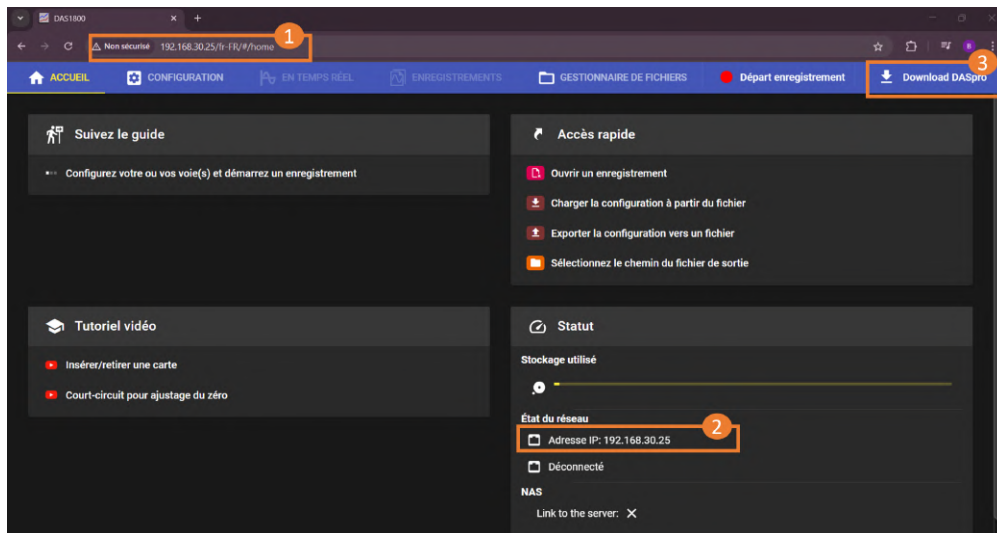

Figure 5.17: Web server



Real-time visualization and file retrieval are not available. To view your measurement data in real time, use the VNC viewer® shown below.

5.7.2 FTP

The FTP protocol enables files to be retrieved or deposited between a remote station and the device. To activate the VNC setting in the device, go to "Configuration" > "Remote Access" > "FTP": check the **Enable** box.

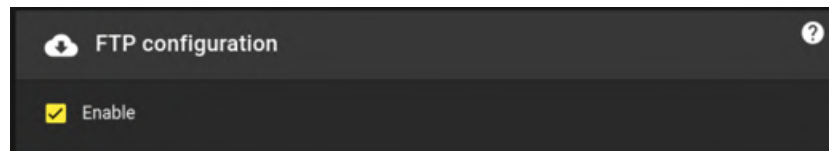

Figure 5.18: FTP configuration

5.7.3 VNC viewer®

You can also use the VNC viewer® utility, freely downloadable from the Internet. It enables you to access your device remotely by duplicating its complete interface on your computer screen.

To activate the VNC setting in the device, go to the “*Configuration*” > “*Remote Access*” > “*VNC*” menu: check the **Enable** box.

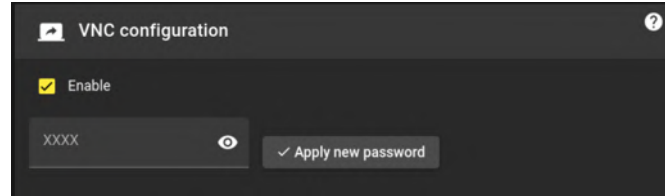

Figure 5.19: VNC configuration

Download the VNC viewer® application, launch the utility and go to File > New connection (1). Enter the device IP address in the VNC server field (2).

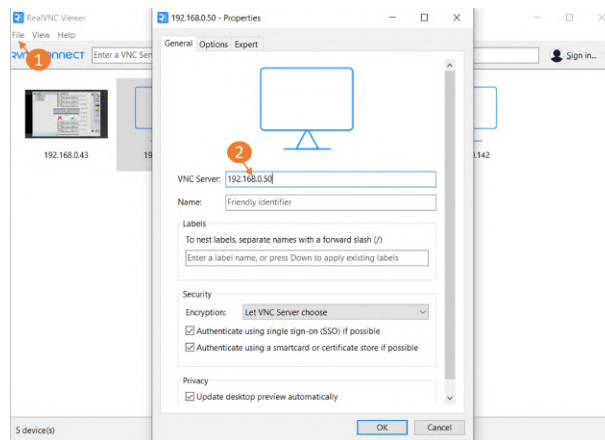

Figure 5.20: New VNC viewer® connection

The new connection appears in the list, click to connect, and you’ll be able to control the device with access to all functions.

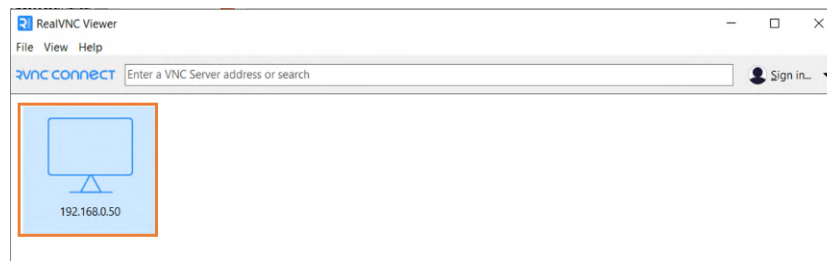

Figure 5.21: Connection



You can secure your connection with a password from the menu.
Standard password : **sefram**

5.7.4 Email

The device can connect to a SMTP server (Simple Mail Transfer Protocol) to send emails when specific conditions occur. The «port» field contains a couple of usual values but, it is possible to fill a custom value. The «subject» and «content» fields will be used for each sent. The device will concatenate them with the cause of the sending e.g. «start record myFile.mf4».



The authentication using an identifier and a password may be unallowed on some servers. In that case please contact your IT administrator to create an application key that you will use as the password of the same identifier.



The 2 buttons at the bottom of the page allow you to check the email configuration before starting a recording.

«Check server connection» validates the device can access the server, ensuring that the address, port, identifier and password are correct.

«Send a test email» can be used afterward to also check the recipient address. It sends a test email which the subject and content are predefined (ignoring the user-defined ones).



To avoid being flagged as spam, the device includes an anti-flood mechanism. It can send up to 4 emails simultaneously (corresponding to the maximum number of simultaneous recordings). The device will then wait at least 10 minutes before sending another email. This prevents dozens of emails from being sent if the reset function is activated with a short recording time.

The screenshot shows a dark-themed web interface titled "Emails server configuration". It contains several input fields: "Server Address*" with the value "smtp.myServer.com", "Server port*" with "587", "Sender email address (identifier on the server)*" with "sender@mail.com", "Password" (masked with dots), "Receiver email address*" with "target@mail.com", "Subject", and "Body content" (with a character count of "0 / 1024"). At the bottom, there are two buttons: "Check server connection" and "Send a test email".

Figure 5.22: Email configuration

5.7.5 SCPI protocol

SCPI (Standard Commands for Programmable Instruments) is a universal programming language for electronic test and measurement instruments, based on the IEEE 488.1 and IEEE 488.2 standards. Commands are ASCII textual strings which are sent to the instrument over the physical layer. Commands are a series of one or more keywords, many of which take parameters.

The SCPI protocol is detailed in the annexes

[See wikipedia description](#)

In DAS interface connection state and error queue can be monitored to help debugging.

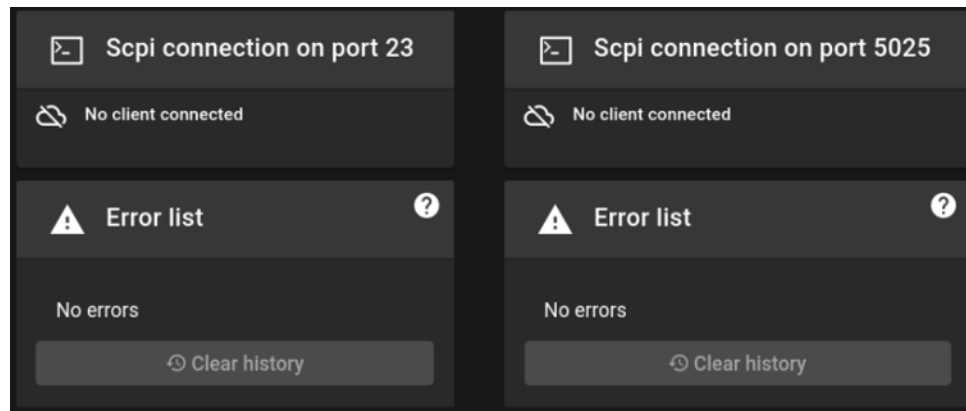

Figure 5.23: SCPI User interface

5.7.6 NAS

A NAS (Network Attached Storage) is a networked storage server, operating in a similar way to a shared hard disk accessible from multiple devices. Prerequisites :

- An operational NAS server connected to the local network.
- Connect the DAS1800 to the same network as the NAS.



The NAS is not supplied by SEFRAM. Its installation, configuration and maintenance are the responsibility of the user IT department.

The screenshot displays the NAS Configuration interface with several panels and fields:

- Server configuration** (Panel 1): Includes an "Enable" checkbox (checked), a "Share URL*" field containing "://192.168.30.223/partage", a "User" field with "Sefram", and a "Password" field (masked with dots).
- Folder synchronization** (Panel 2): Includes an "Enable" checkbox (checked) and a "Synchronised directory" field containing "/".
- Automatically delete the local files after being sent to the server** (Panel 3): An unchecked checkbox.
- NAS Server status** (Panel 4): Shows "Link to the server: ✓" and "Synchronisation: ✓".
- DAS as a server** (Panel 5): Includes an "Enable" checkbox (checked) and a "Password" field (masked with dots).

Orange callouts (1-5) highlight the Share URL field, the User field, the Automatically delete checkbox, the NAS Server status panel, and the DAS as a server panel, respectively.

Figure 5.24: NAS Configuration

Activation

To activate and configure the NAS, start by checking the “Activate” box. Next, fill in all the required information fields (1). The URL entered must contain the server address as well as the full path to the folder on the server where the DAS will deposit files.

Once all fields have been completed, click on the “Apply” button. The NAS status (4) will then update to confirm that activation has been successful.

Automatic synchronization (optional)

Like services such as OneDrive, the DAS1800 automatically synchronizes files **(2)** contained in a folder defined with a NAS. This folder, called the synchronization folder, corresponds to the working directory configured by the user, i.e. where all files will be saved. All files stored in this folder are automatically copied to the NAS, without any manual intervention on the part of the user.



The DAS1800 cannot delete files on the NAS. It can only add files. The user is therefore responsible for managing the storage space on the NAS.
The DAS1800 never sends a file being saved to the NAS. It waits until the recording has been finalized and properly closed before copying.

An option **(3)** allows files to be automatically deleted from the DAS once they have been successfully transferred to the NAS. An integrity check is performed (confirming that the file is present and intact on the NAS) before any deletion. This feature optimizes storage space on the DAS.



This automatic deletion option only applies to files located in the synchronization folder. It does not work in manual mode, i.e. when automatic synchronization is deactivated.

Configuring the DAS as a server

The DAS can be configured to function as a NAS server **(5)**, enabling its storage space to be shared via the SMB protocol. To do this, simply activate the “DAS as server” function in the device settings, define a password, then apply the setting. Once this option has been activated, all data stored on the DAS will be accessible on the local network. The user used for access is predefined as “Samba” and cannot be changed.



Protocol used for communication: samba/CIFS

5.7.7 MODBUS

The Modbus TCP server is an industrial protocol enabling data exchange over Ethernet. A programmable logic controller (PLC), a supervisory system (SCADA), or a testing software can act as a client and connect to the device (the server) to read the values stored in its registers.

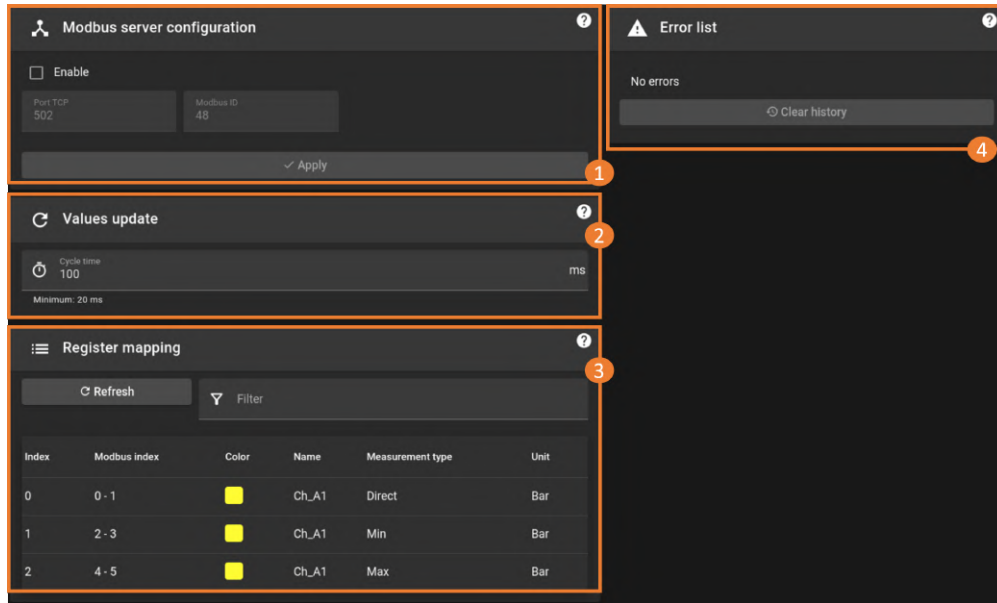

FIGURE 5.25 : Modbus configuration

1. Configuration et activation

- (a) TCP Port : the port number on which the Modbus server listens. The default value is 502.
- (b) Modbus ID : the unit address used by the client to send requests to the server.

2. Value Refresh : This parameter defines the frequency at which the device updates the Modbus input registers. For a PLC, this corresponds to the cycle time or scan time. If the PLC reads the registers faster than the configured period, it may read the same value multiple times. valeur.



To obtain a new value at each PLC cycle, set the refresh period equal to or shorter than the PLC cycle time.

3. Register Mapping : This section explains how the device's active measurements are organized and updated in the Modbus input registers.

- (a) Each measurement uses 2 consecutive 16-bit registers, encoded in IEEE-754 float32 format (low word + high word, big-endian).
- (b) Registers are organized by module address, channel, and measurement type.
- (c) Values are refreshed periodically, with a configurable period in milliseconds.
- (d) Shorter periods provide faster updates but may increase CPU and network load.

4. Status : Communication and alarm status for the Modbus interface.

Chapter 6

Processing & Analysis

6.1 | Power analysis

6.1.1 General information

The power analysis function enables a set of measurements to be taken on a power supply network. The measured quantities can be displayed in real time or saved in a measurement file. Using the power analysis function does not interfere with the operation of the device, and enables other types of data to be recorded. For example, it may be useful to simultaneously record a motor's power supply and mechanical parameters (temperature, torque, rotation speed).

The power analysis function has been designed on the basis of the following standards: IEC 61000-4-30 and IEC 61000-4-7



Only D18-UNIV4, D18-HIV4 and D18-HIZ4 boards are compatible with power analysis. Make sure you have created and configured the channels in the *“Configuration > Analog channels”* section before integrating them into the network analysis.



The device can analyze up to 5 three-phase networks simultaneously

Configuration of compatible networks

DC network :

- 1U/1I

AC network :

- Single phase 1U/1I
- Three phase :
 - Star : 3U/3I and 4U/4I
 - Triangle : 3U/3I

AC networks are compatible with the following frequencies : **50 Hz, 60 Hz** and **400 Hz**.

Calculation method

Calculation intervals : This calculation module uses data sampled at 10kHz. It is compatible with standard 61000-4-30 Power Quality Measurement Methods.

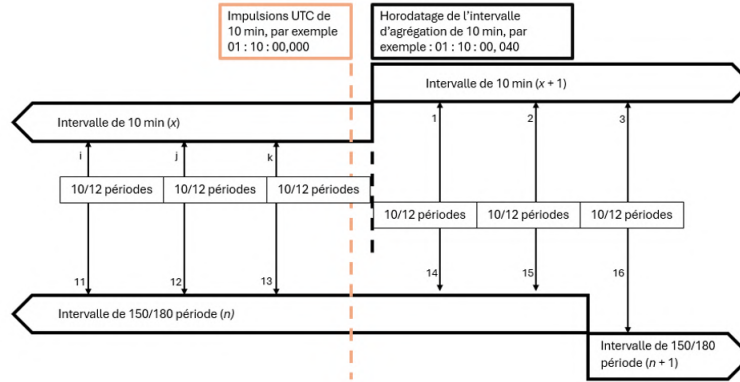

Figure 6.1: Calculation interval

- **10/12 periods** : The first calculation interval is 10/12 periods, 10 signal periods for 50Hz, 12 signal periods for 60Hz and 80 signal periods for 400Hz (approx. 200ms). This interval uses the raw data to perform the calculations.
- **150/180 periods** : The second interval is calculated by aggregating 15 consecutive values from the 10/12 period interval, corresponding to 150 periods for 50Hz, 180 periods for 60Hz and 1200 periods for 400Hz (approx. 3s).
- **10 min** : The third interval is calculated by aggregating consecutive values from the 10/12 period interval. This interval is synchronized to the UTC time stamp with a modulo of 10 minutes.
- **2 h** : The fourth interval is calculated by aggregating 12 consecutive values from the 10min interval. This interval is synchronized to the UTC time stamp with a modulo of 2 hours.

Measurements :

A measurement is a calculation derived from a physical channel.

Temporal : All temporal measurements are performed on the reference channel, using the zero-crossing method.

- **Frequency** : The frequency corresponds to the signal frequency of the reference channel (default: U1/U12), expressed in Hz.
- **Period** : The period corresponds to the time between two zero crossings of the reference signal (default: U1/U12).
- **Time stamp** : Corresponds to the interval end time.

Voltage :

- **RMS** : $RMS = \sqrt{\frac{1}{T} \int_t^{t+T} U^2(t) dt}$

- **DC** : $DC = \sqrt{\frac{1}{T} \int_t^{t+T} U(t) dt}$

- **Low** : Corresponds to the lowest voltage value on the interval.

- **High** : Corresponds to the highest voltage value on the interval.

- **Peak** : Corresponds to the voltage difference between the low and high values : $Peak = |High - Low|$

- **Crest factor** : $CrestFactor = \frac{PEAK}{RMS}$

- **Phase** : Corresponds to the phase shift between the voltage channel and the reference channel U1.

- Sliding reference voltage : $Urg(n) = 0.9967 * Urg_{n1} + 0.0033 * U_{10/12RMS}$

Current :

- RMS : $RMS = \sqrt{\frac{1}{T} \int_t^{t+T} U^2(t) dt}$
- DC : $DC = \sqrt{\frac{1}{T} \int_t^{t+T} U(t) dt}$
- Low : Corresponds to the lowest current value on the interval.
- High : Corresponds to the highest current value on the interval.
- Peak : Corresponds to the current difference between the low and high values : $Peak = |High - Low|$
- Crest factor : $CrestFactor = \frac{PEAK}{RMS}$
- Phase : Corresponds to the phase shift between the current channel and the reference channel U1.
- Factor K : $K = \frac{\sum_{n=1}^h (I_h^2 * h^2)}{\sum_{n=1}^h I^2}$ with $I_h = HarmonicRMSRankh$ and $h = RankHarmonic$

Power :

- Active power : $P = \frac{1}{T} \int_t^{t+T} I(t) * U(t)$
- Reactive power : $Q = \sqrt{S^2 - P^2}$
- Apparent power : $S = U_{RMS} * I_{RMS}$

Energy:

- Active energy : $E_{active} = \int_0^t P(t)$
- Reactive energy : $E_{reactive} = \int_0^t S(t)$

Power quality :

- φ : Corresponds to the value of the phase shift between the current fundamental and the voltage fundamental
- $\cos(\varphi)$
- $\tan(\varphi)$
- Power factor : $PF = \frac{P}{S}$
- THD : $THD = 100 * \frac{\sqrt{\sum_{h=2}^H v_h^2}}{\sqrt{\sum_{h=1}^H v_h^2}}$ with $vh = Valeur de l'Harmonique de rank h$
- Voltage unbalance
- Current unbalance

Voltage harmonics :

- Harmonic : The amplitude of harmonics is evaluated for each voltage up to rank 50 for 50Hz and 60Hz networks, and 10 for 400Hz networks.

Current harmonics :

- Harmonic : The amplitude of harmonics is evaluated for each current up to rank 50 for 50Hz and 60Hz networks, and 10 for 400Hz networks.

6.1.2 Presentation & Programming

Settings

To access the “Power analysis” menus, press “Configuration” > “Analysis” > “Power analysis”.

Alias	Name	Type	Configure	Delete
1	Sefram Tri	3-P AC star	⚙️	🗑️
2	Sefram Mono	1-P AC	⚙️	🗑️

Figure 6.2: Power Analysis Networks

On this page, you’ll find a list of all the networks set up (1) in the DAS1800. To add a new network, press the “Add network” button (2). The configuration page will open. To open the complete network configuration, press the symbol  in the “Configure” column.

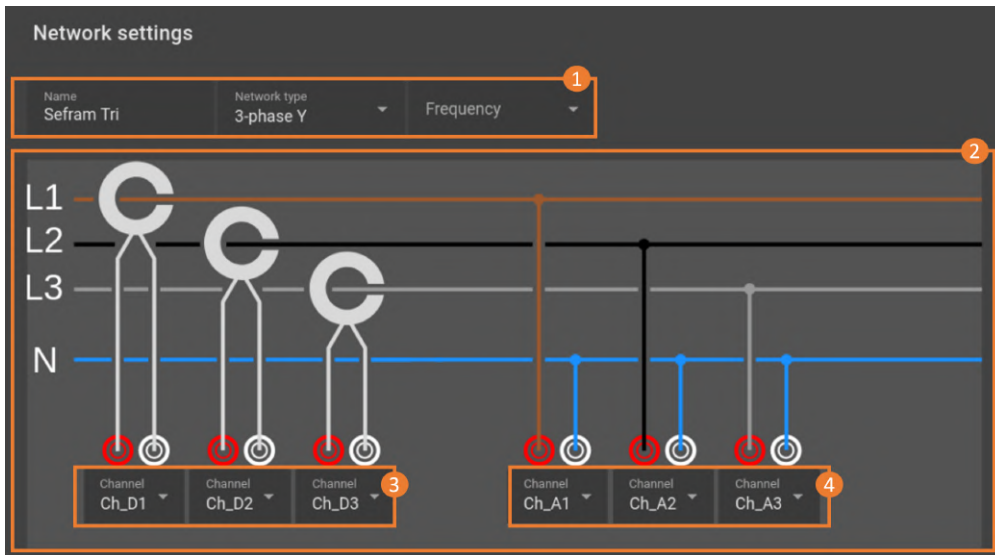

Figure 6.3: Network settings

Field (1) contains general network information and parameters, network name, network type (single-phase, three-phase or DC) and network frequency. The wiring assistance diagram (2) adjusts to the selected network type, to facilitate wiring. Current (3) and voltage (4) channels are configured directly from the help diagram (channel selection is freely up to the user).



Make sure you have created and configured the channels in the *Configuration > Analog channel* section before integrating them into the network analysis.

Field (5) allows you to select the measurements you wish to view or record in the network analysis. By selecting the main measurement (6), all associated measurements are automatically included in the analysis. You can also select a specific measurement (7) by scrolling down the list of options.

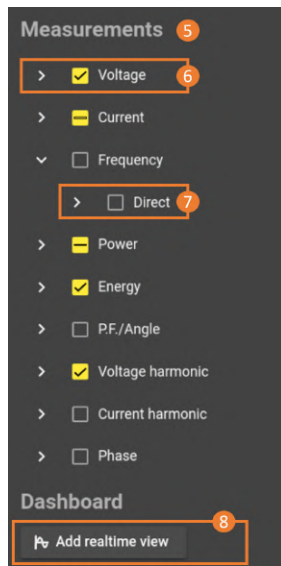

Figure 6.4: Measurement selection

Once your network is configured, you can create a dedicated real-time network view page by clicking on the button **(8)** at the bottom of the parameters.

Analysis

In the real time tab, you can view all energy analysis measurements in real time. You can use all the device standard displays as well as two dedicated energy analysis displays. The analysis screen is available in the “Custom” dashboards.

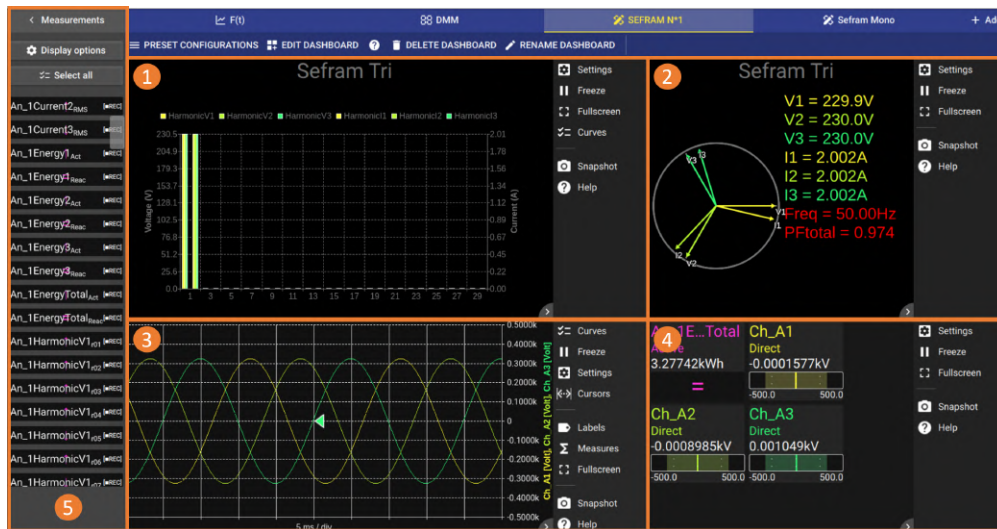

Figure 6.5: Overview of the power analysis screen

The standard network analysis screen is made up of several widgets, including 2 specific ones:

- Histogram **(1)** designed for harmonic analysis and measurement
- Fresnel diagram **(2)** illustrating vectors displaying the phase relationship between voltages and currents. Vector representation enables validation of the device wiring to the network.

As well as 2 other widgets common to the device various applications :

- F(t) graph **(3)** : this mode shows the exact shape of signals, and displays energy analysis measurements as a function of time.
- DMM display **(4)** for precise reading of numerical values of all measurements.

The measured quantities selected in the network configuration are accessible in the side panel **(5)** and can be added to the various diagrams and graphs.

Histogram widget

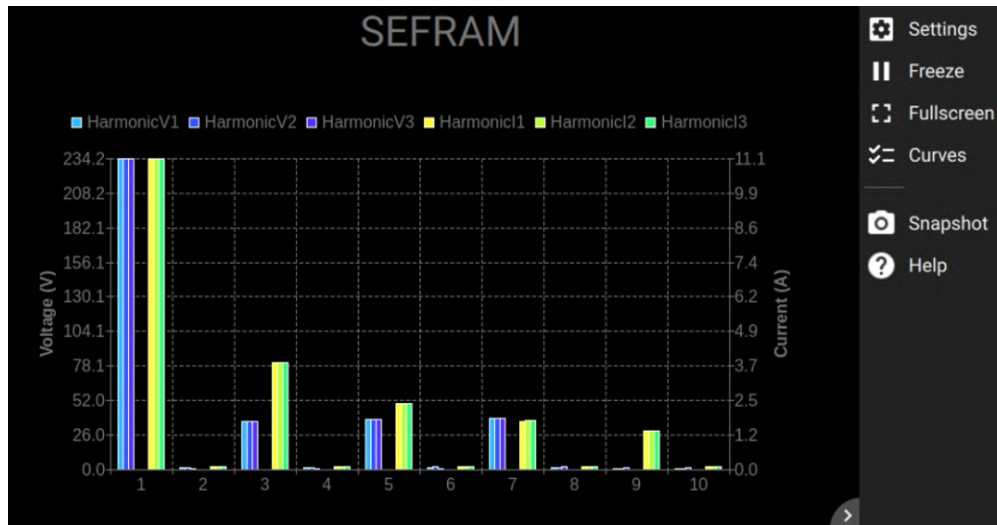

Figure 6.6: Widget Histogram

This widget allows you to analyze network harmonics, from the 1st to the 50th rank. The histogram is linked to a network. The parameters on the right allow you to manage the graph. The “Freeze” button freezes the acquisition on the values currently displayed on the screen, while the “Channels” button lets you add or remove displayed harmonics. A “Help” function is available to guide you in reading and analyzing the graph. Finally, the “Settings” button gives access to the graph options.

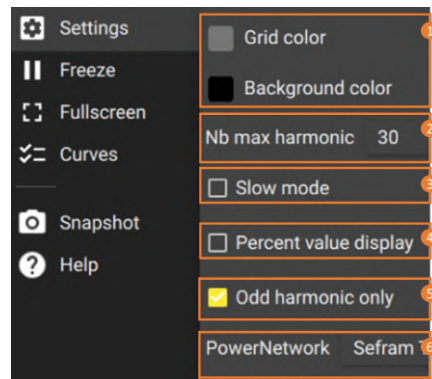

Figure 6.7: Option Widget

These options allow you to customize the graph (1), select the number of harmonics displayed (2), adjust the update speed using the slow mode (3), display harmonic values as a percentage (4), display odd harmonics only (5) or choose the network to be analyzed (6).

Fresnel diagram widget

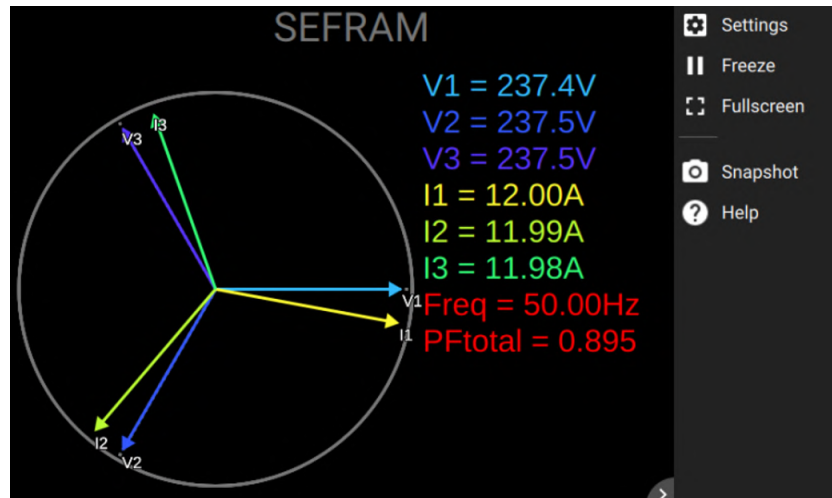

Figure 6.8: Widget diagram Fresnel

The Fresnel diagram presents a vector visualization of the power network, illustrating the phase shift between voltage and current paths. The vector of each input channel is represented in amplitude with the channel's RMS value, and in orientation as a function of its phase shift with respect to the reference channel U1 (Note: the reference channel is configurable in the widget menu).

Like the harmonics widget, the parameters on the right allow you to manage and customize the graph.

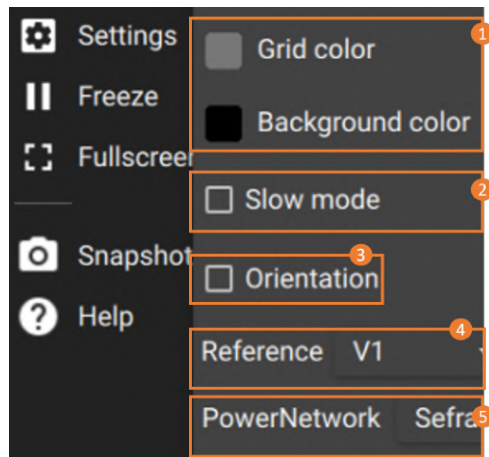

Figure 6.9: Option Widget

These options allow you to customize the graph (1), adjust the refresh rate using the slow mode (2), change the diagram orientation (3) and change the reference channel (4), or choose the network to be analyzed (5).



The use of configurable “Custom X” real-time tabs enables the display to be adapted to specific needs

6.1.3 Data recording

To access the recording frequency settings for energy analysis, press “Configuration” > “Recording” > “Freq. analysis”.

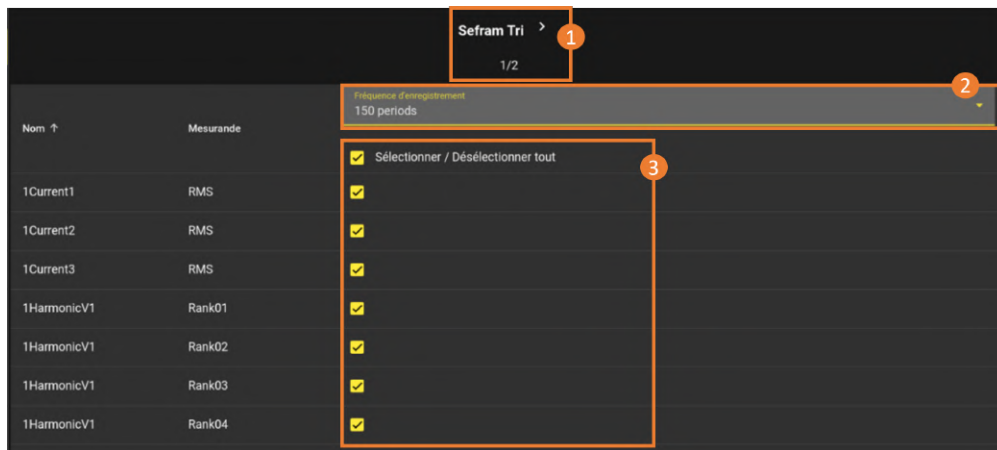

Figure 6.10: Configuration of network analysis recording frequencies

Use the navigation arrows to select the network (1). Once the network to be analyzed has been selected, it is necessary to define the recording frequency for the output file (2). A second step selects the measurements to be included in this file (3).

The measurements displayed in the table correspond to those ticked when the network was created. To add others, simply activate them in the analysis network configuration.



By default, newly activated measurements are recorded at 10 periods.

The output file is consistent with the rest of the device, and will contain the measurements related to energy analysis, as well as the analog channels. Finally, acquisition is launched in the same way as for analog channels.

Chapter 7

MDF4 file format

Measurement Data Format version 4 (MDF4) is an ASAM file standard for storing measurement data in a binary file format. For more information about the MDF4 file format, please visit <https://www.asam.net/standards/detail/mdf/wiki/>.

7.1 | Format

The MDF contains both raw measurement data and the metadata needed to interpret the raw data. The metadata contains, for example, information for converting the raw data into usable physical quantities, or the names of ASAM-compliant signals. The file is organized in binary blocks, where each block consists of a number of adjacent bytes that can be viewed as a record or data structure.

7.2 | Version and compliance with ASAM standard

Our file format follows the MDF 4.1.1 standard, and can be verified using MDF Validator 2.9.10.

7.3 | Interoperability

Our MDF4 files can be read by the following tools:

- Flexpro
- NI DIAdem
- Matlab + Vehicle Network Toolbox
- Python Asammdf
- Turbolab MDF4-LIB

Other software may be able to open our files if they support the MDF4 standard, but we haven't tested them.

7.4 | Functionality

Main MDF4 features in our devices:

- File description fields: allow users to store information about the context of their measurements
- File history: saves the file creation date
- Marker: time markers added by the user
- Raw data: the raw data saved against the conversion functions defined in the header
- Time synchronization information: information on the source and accuracy of time synchronization
- Attachment: the DAS configuration file is included in the registration file as a backup of the device configuration.
- Lane information: lane identifier, short and long lane names, and color of layout
- Downsampling calculated on the fastest frequency group

7.5 | Example

Here's an example of a Python implementation using the Asammdf library to open an MDF4 record

Listing 7.1: Example of using the MDF4 library in Python

```
from asammdf import MDF

mdf = MDF('sample.mdf')
speed = mdf.get('WheelSpeed')
speed.plot()

important_signals = ['WheelSpeed', 'VehicleSpeed', 'VehicleAcceleration']
# get short measurement with a subset of channels from 10s to 12s
short = mdf.filter(important_signals).cut(start=10, stop=12)

# convert to version 4.10 and save to disk
short.convert('4.10').save('important_signals.mf4')

# plot some channels from a huge file
efficient = MDF('huge.mf4')
for signal in efficient.select(['Sensor1', 'Voltage3']):
    signal.plot()
```

Chapter 8

System

8.1 | General settings for man/machine interface

To configure general system settings, go to “*Configuration*” > “*System*”. You will then be able to set :

- **Screen** : brightness management and screen saver configuration
- **Touchscreen** : lock touchscreen or virtual keyboard, unlock password: **Sefram**
- **Keyboard** : regional keyboard selection
- **Sounds** : speaker sound level

8.2 | Time setting

8.2.1 Manual

Set the system time manually.



This parameter is used if the system is isolated (without network) and loses its internal clock. The user can then manually enter the date.

8.2.2 NTP

The device features NTP: Network Time Protocol, a synchronization protocol via IP. NTP enables the device to set its time automatically. An Internet connection (or to a local NTP server) is required to operate.



To set up a local NTP server, contact your IT department, who will be able to help you.

8.2.3 Time zone

This parameter lets you define the time zone to which the device refers.

8.2.4 Synchronization option

The DAS1800 can be equipped, either as a factory option or via a software license, with a time base synchronization system. This feature eliminates long-term drift of the device internal clock, and ensures accurate absolute clock time on the device. Three synchronization modes are available:

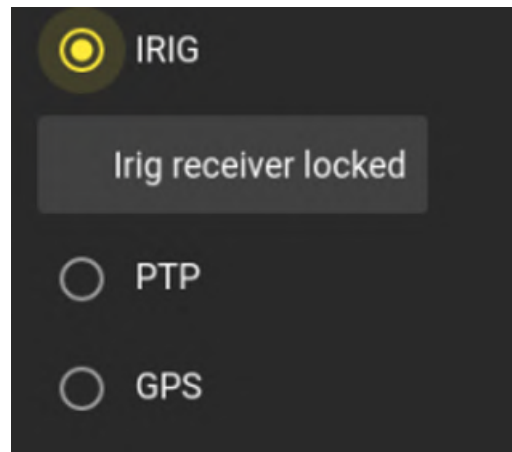

Figure 8.1: Time base synchronization mode

- IRIG (factory option) - B122 / B126: IRIG synchronization is based on the reception of a signal via a coaxial cable. As soon as this cable is connected, the device automatically detects its presence and starts the synchronization process. The device is compatible with 1 kHz modulated IRIG signals.
- GPS (factory option) : Devices equipped with this option feature a dedicated SMA connector, located on the top of the device, for connecting the GPS antenna supplied with the option.
- PTP - Precision Time Protocol (software option) : The IEEE 1588v2 PTP protocol enables time synchronization via the Ethernet network. Once activated, this feature enables the device to automatically synchronize with a PTP source on the network.



To ensure optimum synchronization, use only devices that are compatible with the protocol format. The time master must be in the same subnet as the DAS1800

Synchronization can take between 5 and 10 minutes. A status indicator (on the home page) lets you follow the progress of the process in real time

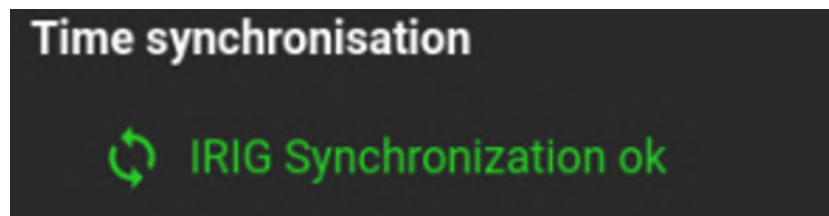

Figure 8.2: Time base synchronization status

- During synchronization, an orange icon appears at the bottom of the screen or on the home screen.
- When synchronization is successful, the icon turns green.
- In the event of failure or error, it turns red.



The system used to develop the IRIG and PTP option is a Meinberg microsinc HR.

8.3 | Network settings

To connect your device to a network, go to “*Configuration*” > “*System*” > “*Network*”.

8.3.1 Ethernet

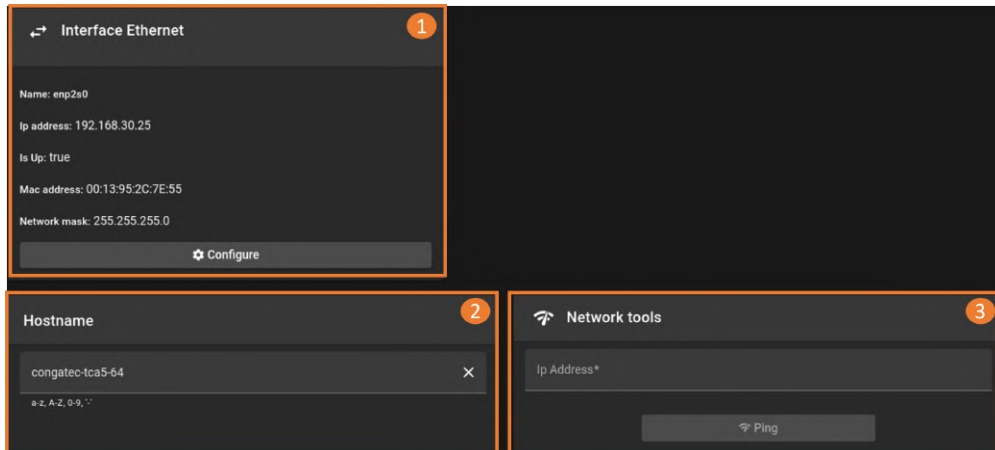

Figure 8.3: Configuration Page

It is possible to configure Ethernet networks on the device simultaneously **(1)**. Assign the name under which the device will be visible on the network(s) **(2)**. The name must begin with a letter and be less than 254 characters long. It cannot consist solely of letters or numbers.

A device reboot is required for the new network name to take effect.



Several combinations can be used simultaneously by configuring the two networks to best support your application:

- Remote control
- Remote file retrieval (FTP function)
- Camera connection with Ethernet interface
- PTP connection for time synchronization between multiple devices

To configure the network, click on "Configure", and the following page will appear :

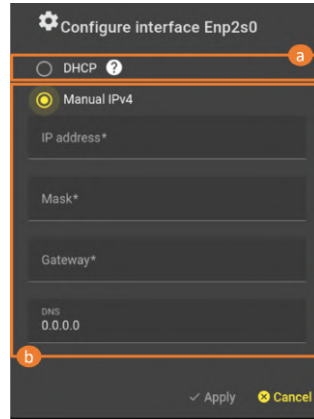

Figure 8.4: Enp2s0 Interface

If your network is directly connected to a DHCP server via a router, you need to check DHCP mode **(a)**. Your network will automatically assign an available network address to your device, thus avoiding address conflicts.

In some cases, if the user has no access to the corporate network, a point-to-point connection is required. This is an isolated connection between the PC and the device. In this case, set the network parameters manually **(b)**.

Example of manual point-to-point network settings:

First, set up a fixed IP on your PC by following the steps below:

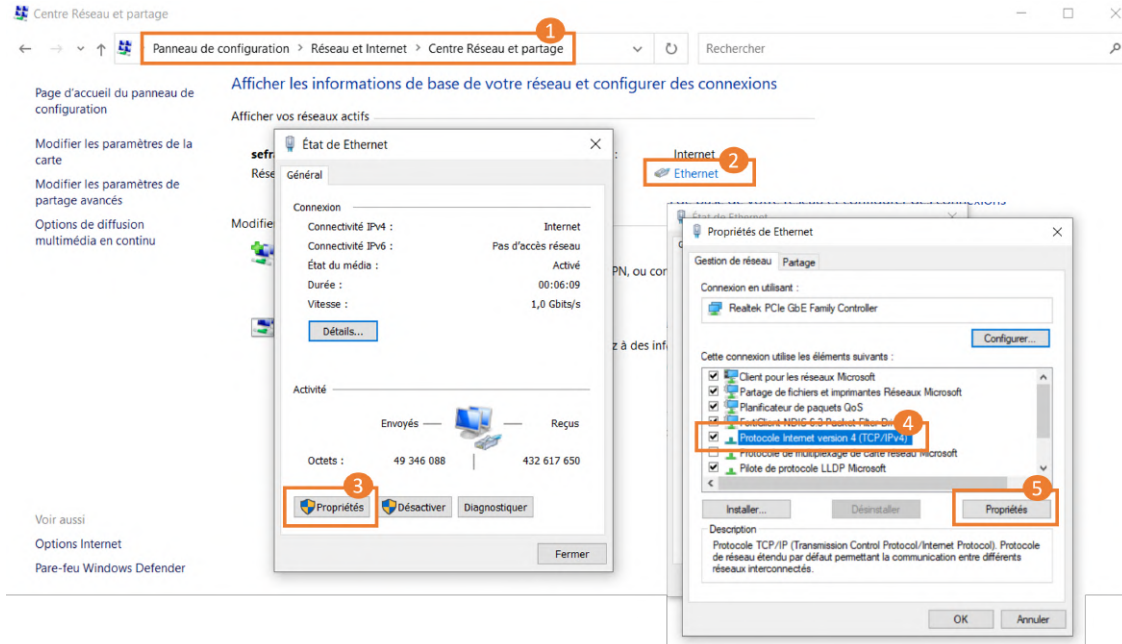

Figure 8.5: Fixed IP address setting

The device is connected to the PC via ethernet cable, and the configurations are as follows :

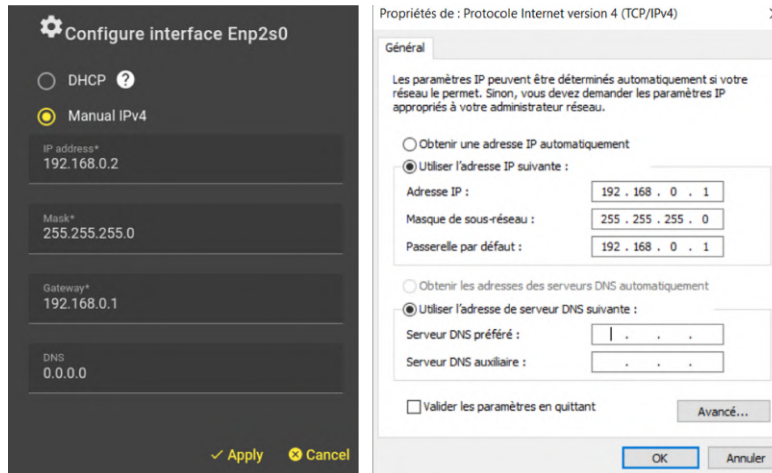

Figure 8.6: Manual IP configuration of PC and the recorder



The configuration shown below is an example. If you have any doubts about your settings, please contact your IT department.



In a point-to-point connection, you can send SCPI commands using the supplied programming manual. This means you can edit and run your own script over an isolated connection.

8.4 | Version

To find out which versions are on your device, go to *“Configuration” > “System” > “Version”*.

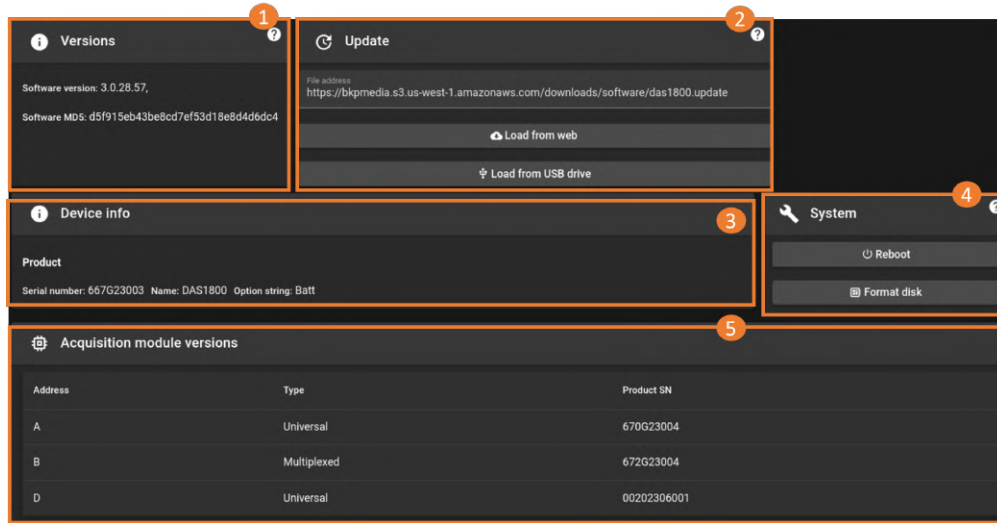

Figure 8.7: System Version Home page

1. Installed software version : The device operates with an upgradeable software version. Enhancements and updates are regularly developed throughout the product's lifetime. Please ensure that your device is always running the latest software version.
2. Software update: To learn more about the software update process, please refer to the dedicated chapter in this manual.
3. General device information
4. System management: This section allows you to restart the device or perform a complete disk format. Formatting erases the entire internal memory, with the exception of the configuration currently in use.
5. Acquisition card versions : Here you'll find information on the versions of the acquisition cards installed on the device.

8.4.1 Software update

Having the latest software version of your device is essential if you are to benefit from the latest improvements and fixes. To update your device, go to *“Configuration” > ‘System’ > “Version”*.

There are 3 ways to update your device:

- Load from the web (1) : the system must be connected to the internet and will automatically download the latest update file from the presented URL.
- Load from USB key (2) : first download the update file from <https://www.sefram.com/mises-a-jour-logicielles.html> and copy it to the root of a USB key. Plug it into one of the device USB ports and click on “Load from USB”
- Load from local file (3) : load the configuration file from the device internal file manager.

From the WEB site (1)

Updating from the website requires the device to be connected to the Ethernet network. To launch the update, simply press the “**Load from website**” button, and the update will be launched automatically.

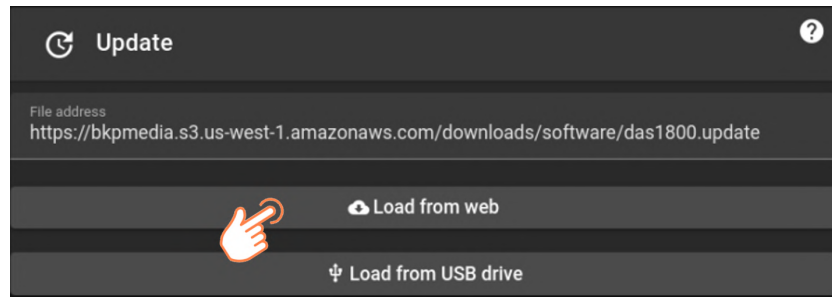

Figure 8.8: Web update option



If the update fails, check the device network connection (Ethernet).

Load from USB key (2)

Retrieve from SEFRAM website <https://www.sefram.com/mises-a-jour-logicielles.html> the DAS1800 software update folder. Do a save-sub and select the USB key.



Use a blank USB key formatted in FAT32.

Plug the USB key into one of the device’s available ports. To launch the update, simply press the “Load from USB key” button, which will launch automatically.

Plug the USB key into one of the device’s available ports. To launch the update, simply press the “**Load from USB key**” button, and the update will be launched automatically.

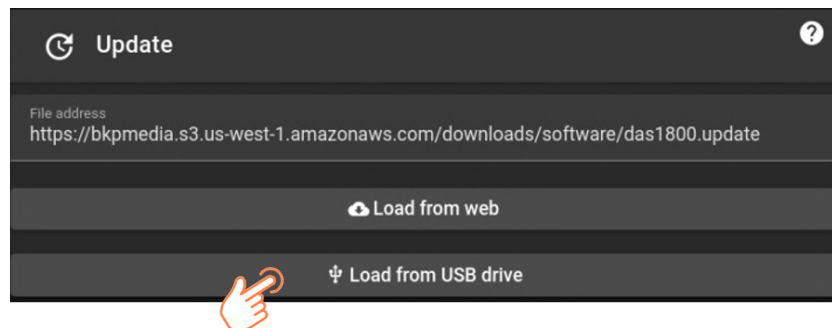

Figure 8.9: USB key option



If the update fails :

- Check that the USB key is detected on the device (error message at the bottom of the screen in case of incorrect reading).
- Check the MAJ file name on the key

Load from local file (3)

If the other 2 semi-automatic update methods have not worked, use this one

1. Go to “Files” > “USB” menu
2. Check the line corresponding to the update file (das1800.update)
3. Press the “Update” button

Update progress

Once the update has been launched, a pop-up window will appear to track its progress.



Figure 8.10: Update pop-up



Do not switch off the device during software update. If using a battery, check that the device has sufficient autonomy. Should the device become unplugged during the update, the system has an internal check to restart the device with the old software version. You will then have to restart the update procedure from scratch.

Once the update has been installed, the “REBOOT” button in the pop-up window should change color. Press it to restart the device with the new version.



Once the device has booted up, an information pop-up appears, confirming that the device has been updated to the new version.

8.5 | User level

To change the user level, go to “*Configuration*” > “*System*”> “*Network*”.

Several user levels can be defined, giving access to more or less advanced functions and information. This is intended to simplify the user interface as required.

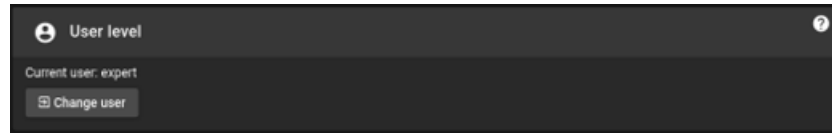

Figure 8.11: User Level

Viewer level :

The device is virtually read-only. The user can only start or stop recording. He/she cannot modify any configuration (network, channels, trigger...) and has no access to the file manager.



For example, this mode is used when an operator has access to the device, but the configuration has been made by a third party. This limits the risk of tampering.

Normal level :

The interface functions available are those intended for standard use. The user has access to virtually all functions.

Expert level :

Certain functions or additional information become available.

Admin level :

This level is dedicated to your company IT department or competent person. It gives access to network security parameters, but disable any modification on the recording settings.

8.6 | Licenses

To configure and manage licenses on the device, go to “*Configuration*” > “*System*” > “*License*”.

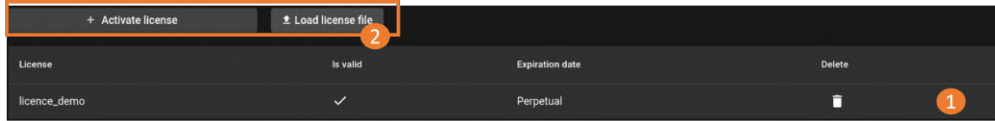

Figure 8.12: License management

Licenses registered on the device (1) are automatically added to a summary table containing the following information:

- License name
- License status
- Expiration date

Activating a license (2) Two methods are available for activating a license:

- Manual activation Enter the license name and activation key.
- Automatic activation Insert a USB key containing the license file. The device will automatically detect and install available licenses.

Deleting a license. To delete a license, press the corresponding icon, then re-enter the same activation key.



Licenses are uniquely associated with the device serial number. A deleted license cannot be transferred or installed on another device.

8.7 | Bug report

If you notice a malfunction when using the device, a dedicated bug report menu is available : *"Configuration"* > *"System"*> *"Bug report"*.

The screenshot shows a dark-themed 'Bug report' form. At the top, there is a title bar with a gear icon and a help icon. Below the title bar are several input fields: 'Author', 'Summary', 'Steps To Reproduce', 'Expected Results', and 'Actual Results'. At the bottom of the form, there are two dropdown menus labeled 'Criticality' and 'Frequency'. Below these are two checkboxes: 'Include system logs file in report' and 'Include configuration file in report', both of which are checked. A 'Save report' button is located at the very bottom. Two orange callout boxes with numbers '1' and '2' are present: box '1' highlights the two checkboxes, and box '2' highlights the 'Save report' button.

Figure 8.13: Create a bug report

Fill in the various fields, providing as much detail as possible. If you suspect a software problem, please check the boxes to include the system and configuration files in the report (1). This will give SEFRAM all the information it needs for a complete diagnosis.

Then press "Save Report" (2), which will create a compressed folder of type xxxx.bugreport in the working directory available from the file manager (see section : [File creation](#)). You can retrieve the file via a USB key or via the network (FTP or web server, see network settings and remote control chapters for more information). Then send the file to SEFRAM's support department: support@sefram.com or support@bkprecision.com for customers in North America.

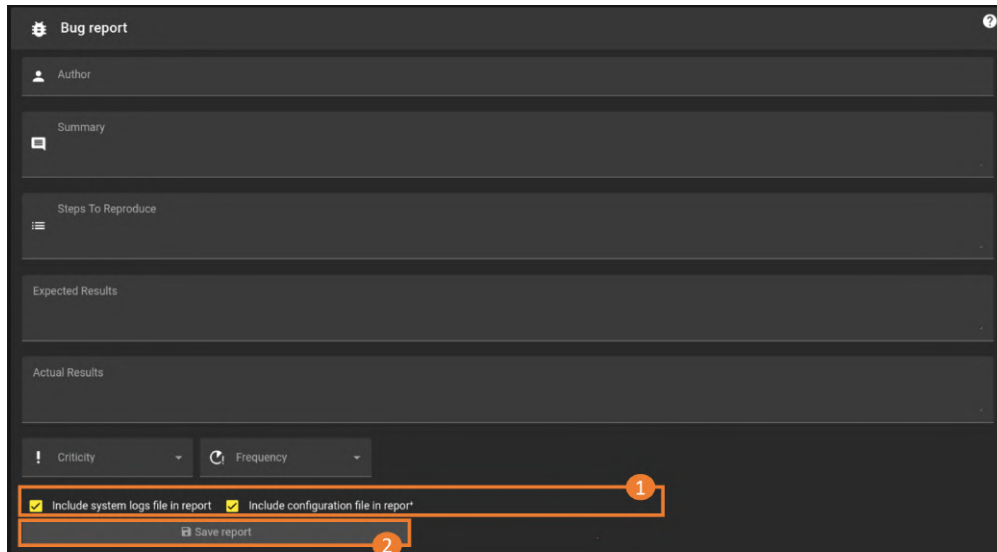

If any doubt, please contact SEFRAM telephone at 04 77 59 01 01. For customers in North America, please contact B&K Precision at 800-462-9832 (US & CAN toll free).

Chapter 9

Procedure and Maintenance

9.1 | Metrology - Calibration

You are in possession of a measuring instrument for which the metrological conditions of measurement are defined in the specifications of this manual. Climatic and environmental conditions limit the specifications of your instrument. SEFRAM checks the characteristics of each instrument individually on an automatic rack during manufacture. Adjustment and verification are guaranteed within the framework of ISO9001 certification by measuring instruments connected to COFRAC (or equivalent in ILAC reciprocity). The advertised characteristics are deemed stable for a period of 12 months from first use, under normal conditions of use. We recommend checking after 12 months, without exceeding 24 months of use. Then every 12 months beyond 24 months. When checking characteristics, it is advisable to respect average climatic conditions (23°C +3°C - 50(+20)%RH) and to operate your equipment for 30 minutes beforehand. We advise you to have this verification carried out by our After-Sales Service to ensure the best possible service and preserve the measurement quality of your instrument. When a product returns to SEFRAM or B&K Precision, a full service is provided, including an internal upgrade to keep pace with the latest developments, and a software upgrade. In the event of any deviation from specifications, your instrument will be adjusted to regain its original characteristics.

9.2 | Cold junction adjustment procedure

This procedure follows the instructions in the integrated video tutorial, accessible via the *“Run thermocouple cold junction calibration”* option. It completes the explanations given in paragraph entitled *“Calibration”*. It is compatible with D18-UNI4 universal boards.



Figure 9.1: Run thermocouple cold junction calibration button

Click on the *“Run thermocouple cold junction calibration button”* button to open the calibration window.

Step n° 1 : Connect the channel(s) to be adjusted to a temperature standard or calibrator, ensuring correct polarity between the V+ and V- terminals. Refer to the DAS1800 video tutorial for more details. Once connected, press the *“Next”* button **(1)** to go on to step 2.



Figure 9.2: Connecting thermocouples and standard/calibrator

Step n° 2 : Channel settings to be adjusted.

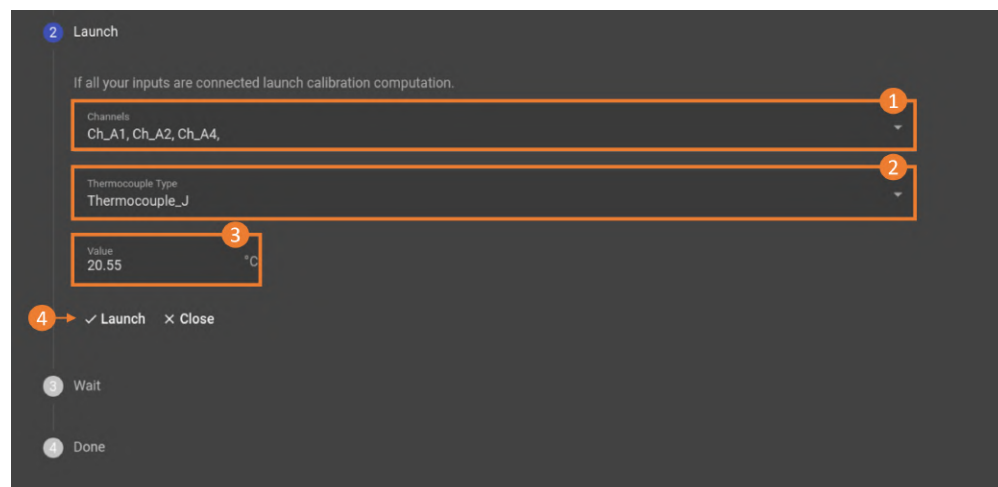

Figure 9.3: Adjustment settings

1. Select the channel(s) to be adjusted.
2. Select the type of thermocouple incorporated in the standard or calibrator.
3. Enter the value displayed on the standard or calibrator.
4. Press "Lunch". The DAS1800 automatically starts the cold junction compensation procedure.

9.3 | Zero adjustment procedure

This procedure follows the instructions in the built-in video tutorial, accessible via the “Perform zero adjustment” option. It completes the explanations given in paragraph entitled “Calibration”. It is compatible with D18-UNI4 universal boards.

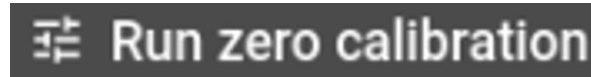

Figure 9.4: Run zero calibration button

Click on the “Run zero calibration” button to open the calibration window.

Step n° 1 : Short-circuit the universal inputs of the D18-UNI4 board according to the assembly diagram (1). Then connect the inputs to the DAS1800 ground terminal (2). You can refer to the tutorial video included with the DAS1800 for guidance. Once connected, press the “Next” button to go on to step 2.

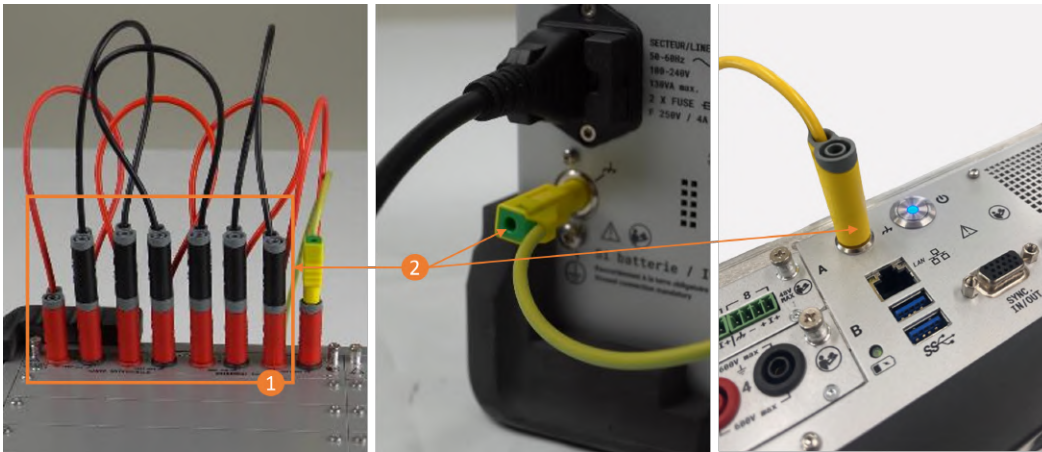

Figure 9.5: Connecting universal inputs

Step n° 2 : Select the card to be adjusted



Figure 9.6: Card selection

Select the universal board to be adjusted (1), then press “Start”. The DAS1800 automatically initiates the cold junction compensation procedure.

9.4 | Case study : Sensor Examples

9.4.1 Pressure Sensor Type 4 - 20mA with 50 Ohm Shunt

To perform a current measurement (without a clamp), it is imperative to have a shunt connected to the input of the channel. A shunt is a resistor that allows the current to be converted into voltage so that the measurement can be performed by the device.

Sensor Parameters

- Output signal: 4 - 20 mA
- Measurement range (physical measurement): 0 - 110 Bar

Sensor Configuration

The output signal is pre-filled by the recorder. You only need to enter the sensor measurement range in the fields indicated in blue. The value of the shunt used must be selected on the configuration page of a channel.

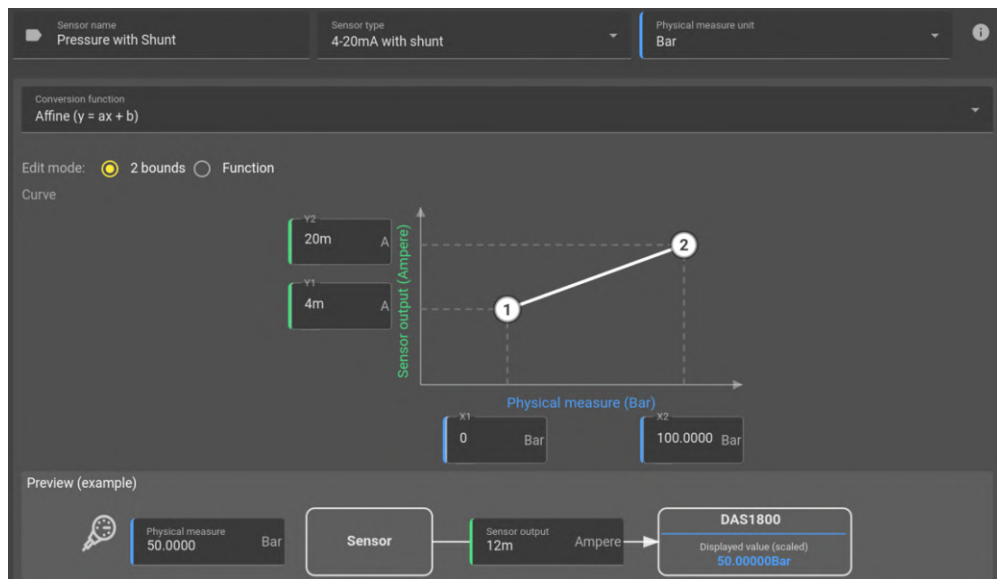

Analog Channel Configuration

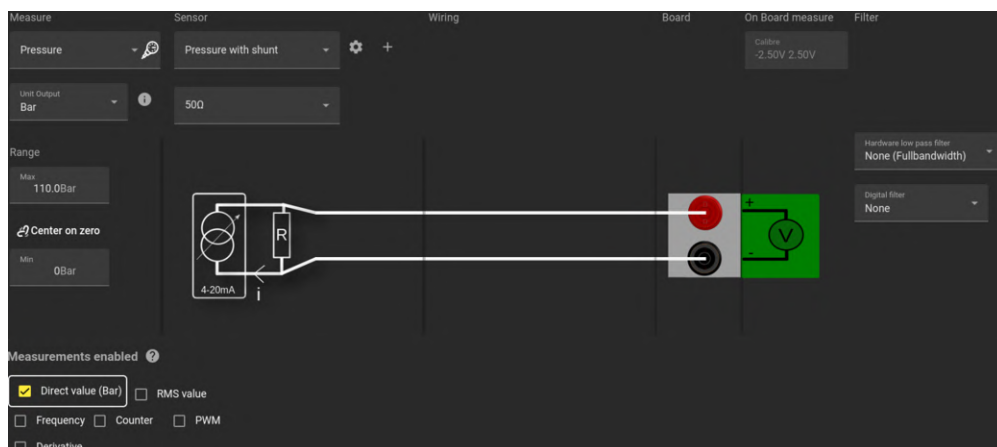

9.4.2 Capteur pression type 0 - 10 V

For the configuration of a 0–10 V type sensor, you can use either the Linear function or the Affine function. In this example, the setup is performed using the Affine mode with a two-point configuration. This method allows defining the relationship between the measured voltage and the associated physical value by specifying two reference points.

Sensor Parameters

- Output signal: 0 - 10 V
- Measurement range (physical measurement): 0 - 110 Bar

Sensor Configuration

The output signal is pre-filled by the recorder. You only need to enter the sensor's measurement range in the fields highlighted in blue for a channel.

The screenshot displays the 'Conversion function' settings for an affine function ($y = ax + b$). The 'Edit mode' is set to '2 bounds'. A graph shows the relationship between 'Physical measure (Bar)' on the x-axis and 'Sensor output (Volt)' on the y-axis. Two points are marked: Point 1 at (0 Bar, 0 V) and Point 2 at (100.0000 Bar, 10.0000 V). Below the graph, the physical measurement range is set to 0 Bar (X1) and 100.0000 Bar (X2). A warning message states 'Warning this is a linear conversion'. A 'Preview (example)' section shows a flow: Physical measure (10.0000 Bar) → Sensor → Sensor output (1.00000 Volt) → DAS1800 (Displayed value (scaled) 10.00000Bar).

Analog Channel Configuration

The screenshot shows the 'Analog Channel Configuration' for a 'Pressure 0 - 10 V' sensor. The 'Measure' section is set to 'Pressure' with a unit of 'Bar'. The 'Range' is set to 'Max: 110.0Bar' and 'Min: 0Bar'. The 'Center on zero' option is checked. The 'Measurements enabled' section has 'Direct value (Bar)' checked, with 'Frequency' and 'Counter' unchecked. The 'Wiring' section shows the sensor connected to the board. The 'Board' section shows the 'On Board measure' set to 'Calibra -25.0V 25.0V'. The 'Filter' section has 'Hardware low pass filter' set to 'None (Fullbandwidth)' and 'Digital filter' set to 'None'.

Chapter 10

Technical specifications

Specifications, base unit

Note: All specifications apply to the unit after a temperature stabilization time of 60 minutes over an ambient temperature range of $23\text{ }^{\circ}\text{C} \pm 5\text{ }^{\circ}\text{C}$.

Data Acquisition System		
Recording (files written to SSD)		
Max Sampling Rate ¹	1 MSa/s up to 8 channels	
Recording Groups	3	
Write Speed	50 MB/s	
File Format	ASAM MDF4 (.mf4)	
File Size Limit	90% of disk capacity	
At End of Acquisition	Notify, rearm trigger	
Markers	On user action, On event	
Real Time Measure		
Display Mode	F(t)	Roll mode: 100 ms/div to 10 min/div Scope mode: 10 μ s/div to 50 ms/div
	DMM	Acquisition time: 200ms (10 NPLC ² at 50Hz), 2s (100 NPLC ² at 50Hz)
		Display mode: Bargraph, reduce, MIN/MAX
	Record live view	Typical Refresh period 2s, Zoom Mode
	Phasor Diagram	Data sampled at 10 kHz Vector amplitude based on RMS value
	Histogram	50 Hz to 60 Hz: 1 to 50 harmonics 400 Hz: 1 to 10 harmonics
Custom	Customize up to 10 dashboards with unique widget arrangements Widgets: F(t), Record Live F(t), DMM, Phasor diagrams, Histogram, Images	
File Viewer		
Open File Time (typical)	10 sec per 100 GB of file ³	
Subplot	16	
Cursors	Horizontal, vertical	
Measurements	On the data displayed or between cursors	
	Min, Max, Pk to Pk, Frequency, RMS, Rising time	
Trigger System		
Compute Period	1 μ s	
Source	Analog and logic channel, external source, manual, date/time, delay (on start), duration (on stop), AND/OR combination of channels (128 max)	
On Analog Channel	Edge (rising, falling, both), Threshold (above, below), windows (in, out)	
Pre-trigger	128 M samples	
Post-trigger	1000 s maximum	

Digital I/O	
Input	
Number of Channels	16
Max Voltage	24 V
Threshold	1.2 V to 2.8 V
Sampling Interval	1 μ s (1 MSa/s) each channel
Output	
Number of Channels	4
Output Characteristics	TTL 5 V, 10 mA
Trigger Source	Analog/Digital channels, acquisition start/stop, disk full
Power Supply ⁴	+ 12 V \pm 5 %, 200 mA

Synchronization		
Sync and Trigger I/O (SUB-D 15 HD Connector)		
Input	Signal level	TTL 3.3 V
	External trigger	Pull-up resistor: 10 k Ω , Rising edge sensitive Minimum pulse width: 100 μ s
	External start/stop	Pull-up resistor: 10 k Ω , Rising edge sensitive for start Falling edge sensitive for stop Minimum pulse width: 500 ms
Output	Signal	TTL 3.3 V
	Trigger	1 ms positive pulse at trig event
	Start/stop	Set when record is launched
IRIG and GPS (option)		
IRIG/GPS Input	IRIG format B122/B126 Time error between reference clock and acquisition clock, < \pm 10 μ s	
PTP (option)		
Ethernet PTPV2 IEEE 1588	Time error between reference clock and acquisition clock, < \pm 10 μ s	

Software Feature		
Remote Access	VNC for remote monitoring and control	
	Web server	
	Event notify	Email
	File management	FTP NAS (Network storage for file backup)
	Bench automation	SCPI command port (23 or 5025)
Storage Management	Cleaning policy option for automatically removing old files after exceeding a specific number of files or a date	
Sensor Library	Predefined sensors and user created	
Date and Time	Manual, NTP	
Software Update	Through web or USB	
Languages	English, French, Portuguese, Chinese, Spanish, German	

(1) For D18-UNI4 and D18-HIZ4 Module

(2) NPLC: Number of power line cycles

(3) Time with only the 1st frequency group used

(4) Used to power the isolated digital input board

Specifications, base unit

Note: All specifications apply to the unit after a temperature stabilization time of 30 minutes over an ambient temperature range of 23 °C ± 5 °C.

Power Analysis					
General					
Network Type	DC: AC: Single-phase (1U/1I), 3-phase delta (3U/3I), 3-phase Wye in 3-wire (3U/3I) and 4-wire (4U/4I)				
Network Frequency	DC, 50Hz, 60Hz, 400Hz				
Sampling Rate	10 kHz				
Number of Networks	5				
Compatible Modules	D18-UNIV4 & D18-HVM4 & D18-HIZ4				
Record File	MDF4				
Calculation Interval					
Network Frequency	1st Interval	2nd Interval	3rd Interval	4th Interval	5th Interval (custom)
DC	200 ms	3 s	10 min	2 h	1 ms to 100 ms
50 Hz	10 periods	150 periods	10 min	2 h	1-2-5 period
60 Hz	12 periods	180 periods	10 min	2 h	1-2-5 period
400 Hz	80 periods	1200 periods	10 min	2 h	1-2-5-10-20-40 period
DC Measurements					
Voltage	Mean, Max, Min, peak-to-peak			0.1% U _{din} ⁽¹⁾	
Current	Mean, Max, Min, peak-to-peak			0.1% I _{din} ⁽²⁾	
Power	Active			0.1% P _{din} ⁽³⁾	
Energy	Active			-	
AC Measurements					
Voltage	Mean, True RMS, Max, Min, peak-to-peak, Crest factor			0.1% U _{din} ⁽¹⁾	
	Phase to ref channel			± 0.5°	
Current	Mean, True RMS, Max, Min, peak-to-peak, Crest factor			0.1% I _{din} ⁽²⁾	
	Phase			± 0.5°	
	K factor			0.1%	
Power	Active, Reactive, Apparent			0.1% P _{din} ⁽³⁾	
Power Quality	cos (Φ)			± 0.01	
	tan (Φ)			-	
	Φ			± 0.5°	
	PF			± 0.001	
	THD			1.0%	
Energy	Active, Reactive			-	
Voltage Harmonics	50 Hz, 60 Hz: 1 to 50 harmonics			0.1% U _{din} ⁽¹⁾	
	400 Hz: 1 to 10 harmonics				
Current Harmonics	50 Hz, 60 Hz: 1 to 50 harmonics			0.1% I _{din} ⁽²⁾	
	400 Hz: 1 to 10 harmonics				

(1): U_{din}— Nominal network voltage

(2): I_{din}— Nominal network current

(3): P_{din}— Nominal network power (U_{din}*I_{din})

General	
Internal Solid State Memory	SSD 3D NAND Flash - 500GB
Operating Temperature	0 °C to 40 °C (32 °F to 104 °F)
Storage Temperature	-20 °C to 60 °C (-4 °F to 140 °F)
Display	12" HD touchscreen (1200 x 800)
Power Supply	110 VAC to 240 VAC, 50 - 60 Hz (75VA max)
Interfaces	USB3.0 (x2) and LAN 1Gbps (x1)
Battery (optional)	Removable, Lithium-ion - 10.8 V, 75 Wh
Battery Life (typical)	4H- One Module D18-UN14 installed 3H30 - Two Module D18-UN14 installed
Weight	5Kg - Two Module installed + Battery option 4.5Kg - One Module installed + Battery option
Safety	Low Voltage Directive (LVD) 2014/35/EU EN 61010-2010+A1:2019, EN 61010-2-030 (2021+A11/2021)
Electromagnetic Compatibility	EMC directive 2014/53/EU, EN IEC 61326-2-1 (2021) EN IEC 61326-1 (2021), EN 61000-3-2 (2019+A1/2021) EN 61000-3-3 (2013+A1/2019)
Dimensions (WxHxD)	15.7" x 9.6" x 4.7" (400 x 245 x 120 mm)
Warranty	3 Years
Supplied Accessories	Power cord, SUB-D 25 pin male connector and back shell, SUB-D 15 pin male connector and back shell, rugged carrying case

Specifications, measurement Modules

Note: All specifications apply to the unit after a temperature stabilization time of 30 minutes over an ambient temperature range of 23 °C ± 5 °C.

Universal Module (D18-UNI4)		
Number of Channels	4	
Input Type	Isolated single ended input - 4mm Banana Plug	
Voltage		
Max. Input Voltage	± 600 VDC or 424 Vrms	
Common-mode Voltage	600 V between track and ground	
Range (19 ranges)	± 500 μ V / 1 mV / 2.5 mV / 5 mV / 10 mV / 25 mV / 50 mV / 100 mV / 250 mV / 500 mV / 1 V / 2.5 V / 5 V / 10 V / 25 V / 50 V / 100 V / 250 V / 600 V	
DC Accuracy ¹	≤ ± 25 mV	± 0.1% of full range + 10 μ V ²
	± 25 mV to ± 500 mV	± 0.1% of full range + 10 μ V
	≥ ± 1 V	± 0.06% of full range
Offset Drift	± 50 ppm/°C ± 1 μ V/°C	
Input Impedance	1 M Ω for ranges ≥ ± 1 V, 25 M Ω for ranges ≤ ± 0.5 V	
Input Capacitance	150 pF	
Intrinsic Noise ³ (standard deviation in % of the span)	≤ ± 1 mV	< 0.2%
	± 2.5 mV to ± 10 mV	< 0.1%
	± 25 mV to ± 500 mV	< 0.05%
	≥ ± 1 V	< 0.02%
CMRR	≤ ± 500 mV	> 85 dB
	≥ ± 1 V	> 70 dB
Crosstalk	> -90 dB	
Isolation	CH to CH and CH to GND, > 100 M Ω at 650 VDC	
Safety	CAT III 600 V	
Bandwidth and Filters		
Bandwidth (-3 dB)	≤ ± 2.5 mV	1 kHz
	± 5 mV to ± 25 mV	10 kHz
	± 50 mV to ± 500 mV	60 kHz
	≥ ± 1 V	100 kHz
Analog Filter	2nd Order(-20 dB/dec)	100 Hz, 1 kHz, 10 kHz
Digital Filter	IIR 4th order (-80 dB/dec)	0.01 Hz to 10 kHz
	Type	Low pass, high pass, band pass, band stop
	Filter response	Butterworth, Bessel, Chebyshev, Inverse Chebyshev, elliptic, Papoulis, Gaussian
Temperature (Thermocouple)		
Compute Frequency	4 ms	
Cold Junction	Uncompensated, internal, external (other channel)	
	Accuracy ⁴ : ± 1.25°C	
Type	J	-210 °C to 1200 °C (-346 °F to 2192 °F)
	K	-250 °C to 1370 °C (-418 °F to 2498 °F)
	T	-200 °C to 400 °C (-328 °F to 752 °F)
	S	-50 °C to 1760 °C (-58 °F to 3200 °F)
	B	200 °C to 1820 °C (392 °F to 3308 °F)
	E	-250 °C to 1000 °C (-418 °F to 1832 °F)
	N	-250 °C to 1300 °C (-418 °F to 2372 °F)
	R	-50°C to 1768°C (-58 °F to 3214 °F)

Data Acquisition		
ADC	16 bit – SAR	
Sampling Interval	1 μ s (1 MSa/s) each channel	
Time and Counting		
Threshold	Set by user, auto	
Duty Cycle	10% minimum – (minimum pulse width, 20 μ s)	
Counter	48 bits	
Frequency	0.1 Hz to 100 kHz	
	Accuracy: 0.01% reading, 0.1 Hz to 10 Hz 0.05% reading, 10 Hz to 100 kHz	
PWM	Absolute error: 0.1% from 0.1 Hz to 1 kHz 0.5% from 1 kHz to 5 kHz	
True RMS		
Compute Period	Compute on the 1 Ms/s data flow Each period until 100 Hz 10 ms between 100 Hz and 10 kHz	
Accuracy (Sine wave ≥ 1 V)	10 Hz to 2 kHz	± 0.1% of full range
	2 kHz to 10 kHz	± 0.3% of full range
Other		
Current	Through shunt or clamp	
Sensor	0 to 10 V, 4 to 20 mA (with external shunt), duty cycle or frequency sensor, other user defined settings	
Calculations	Min - max - avg - pk to pk on Δ t, integral, and derivative	

High Impedance Module ⁵ (D18-HIZ4)		
Voltage		
Input Impedance	10 M Ω for ranges ≥ ± 1 V, 25 M Ω for ranges ≤ ± 0.5 mV	
Intrinsic Noise ³ (standard deviation in % of the span)	≤ ± 1 mV	< 0.2%
	± 2.5 mV to ± 10 mV	< 0.1%
	± 25 mV to ± 500 mV	< 0.05%
	≥ ± 1 V	< 0.05%
Bandwidth and Filters		
Bandwidth	≤ ± 2.5 mV	1 kHz
	± 5 mV to ± 25 mV	10 kHz
	± 50 mV to ± 500 mV	60 kHz
	≥ ± 1 V to ± 10 V	20 kHz
	≥ ± 25 V	80 kHz

- (1) Direct measure taken on DMM at 10 (50 Hz) / 12 (60 Hz) NLPC (200 ms) and full bandwidth
- (2) Only when offset adjustment has been performed after installing a new module. Otherwise accuracy is ± 0.1% of full range (max. range - min. range) + 20 μ V
- (3) Measure ± short circuit termination to 50 Ω on chassis during 1 sec at the fastest acquisition speed and full bandwidth
- (4) Only when cold junction adjustment has been performed after installing a new module and after 30 minutes of connection between TLK2B accessory, thermocouple and module terminal. Otherwise accuracy is ± 3 °C
- (5) For all other specs, refer to the universal module specifications

Specifications, measurement Modules

Note: All specifications apply to the unit after a temperature stabilization time of 30 minutes over an ambient temperature range of 23 °C ± 5 °C.

Multiplexed Module (D18-MUX8)		
Number of Channels	8	
Input Type	Non-isolated differential input – 4 pin terminal block, Part: Phoenix Contact MC 1.5/ 4-ST-3.5	
Voltage		
Maximum Input Voltage	± 48 VDC between CH to GND and between 2 poles on a channel	
Range (16 ranges)	± 500 μV / 1 mV / 2.5 mV / 5 mV / 10 mV / 25 mV / 50 mV / 100 mV / 250 mV / 500 mV / 1 V / 2.5 V / 5 V / 10 V / 25 V / 48 V	
Admissible Common Mode	≤ ± 1 V	± 3 V
	≥ ± 2.5 V	± 48 V
DC Accuracy ¹	≤ ± 10 mV	± 0.1% of full range + 5 μV
	≥ ± 25 mV	± 0.04% of full range
Offset Drift	± 50 ppm/°C ± 0.5 μV/°C	
Input Impedance	2 MΩ for ranges ≥ ± 1 V, 25 MΩ for ranges ≤ ± 0.5 V	
Input Capacitance	150 pF	
Intrinsic Noise ² (standard deviation in% of the span)	≤ ± 1 mV	< 0.15%
	± 2.5 mV to ± 10 mV	< 0.05%
	≥ ± 25 mV	< 0.01%
CMRR	> 70 dB	
Crosstalk	> -90 dB	
Bandwidth and Filters		
Bandwidth (-3 dB)	1 kHz	
Digital Filter	IIR 4th order (-80 dB/dec)	0.01 Hz to 500 Hz
	Type	Low pass, high pass, band pass, band stop
	Filter response	Butterworth, Bessel, Chebyshev, Inverse Chebyshev, elliptic, Papoulis, Gaussian
Data Acquisition		
ADC	18 bit – SAR	
Sampling Interval	200 μs (5 kSa/s) each channel	

Temperature (RTD)		
Compute Frequency	4 ms	
Current	Pt100	1.0 mA
	Pt200	0.5 mA
	Pt500	0.2 mA
	Pt1000	0.1 mA
Temperature Range	-200 °C to +850 °C (-328 °F to 1562 °F)	
Wiring	2 wires	Max. corrective resistance 50 Ω
	3 wires	Max. 3-wire resistance, 50 Ω
	4 wires	
Measurement Range (7 Ranges)	± 10 °C, ± 25 °C, ± 65 °C, ± 130 °C, ± 200 °C, [-200 °C, +380 °C], [-200 °C, +850 °C]	
Accuracy	3 wires	± 0.1% of the range ± 0.3 °C
	4 wires	± 0.1% of the range ± 0.2 °C

Temperature (Thermocouple)		
Compute Frequency	4 ms	
Cold Junction	Uncompensated, internal, external (other channel)	
	Accuracy ³ : ± 1.25 °C	
Type	J	-210 °C to 1200 °C (-346 °F to 2192 °F)
	K	-250 °C to 1370 °C (-418 °F to 2498 °F)
	T	-200 °C to 400 °C (-328 °F to 752 °F)
	S	-50 °C to 1760 °C (-58 °F to 3200 °F)
	B	200 °C to 1820 °C (392 °F to 3308 °F)
	E	-250 °C to 1000 °C (-418 °F to 1832 °F)
	N	-250 °C to 1300 °C (-418 °F to 2372 °F)
	R	-50 °C to 1768 °C (-58 °F to 3214 °F)
Resistance		
Compute Frequency	4 ms	
Wiring	2 wires	Max. corrective resistance 50 Ω
	3 wires	Max. 3-wire resistance, 50 Ω
	4 wires	
Measurement Range (4 Ranges)	300 Ω (1 mA), 1500 Ω (0.5 mA), 5k Ω (0.2 mA), 10 kΩ (0.1 mA)	
Accuracy	± 0.1% of the range ± 0.1 Ω	
Time and Counting		
Threshold	Set by user, auto	
Minimum Pulse Width	1 ms	
Counter	32 bits	
Other		
Current	Through shunt or clamp	
Sensor	0 to 10 V, 4 to 20 mA (with external shunt), other user defined settings	

- (1) Direct measure taken on DMM at 10 (50 Hz) / 12 (60 Hz) NLPC (200 ms) and full bandwidth
- (2) Measure ± short circuit termination to 50 Ω on chassis during 1 sec at the fastest acquisition speed and full bandwidth
- (3) Only when cold junction adjustment has been performed after installing a new module and after 30 minutes of connection between GCMSP accessory, thermocouple and module terminal. Otherwise accuracy is ± 3 °C

Specifications, measurement Modules

Note: All specifications apply to the unit after a temperature stabilization time of 30 minutes over an ambient temperature range of 23 °C ± 5 °C.

High Voltage Module (D18-HVM4)		
Number of Channels	4	
Input Type	Isolated differential input - 4mm Banana Plug	
Voltage		
Max. Input Voltage	± 1500 VDC or 1000 Vrms	
Overvoltage Protection	± 2000 VDC or 1414 Vrms ⁽³⁾	
Range (9 ranges)	± 5 V / 10 V / 25 V ± 50 V / 100 V / 250 V ± 500 V / 1000 V / 2000 V	
DC Accuracy ⁽¹⁾	± 0.06% of full range	
Offset Drift	± 50 ppm/°C ± 1 µV/°C	
Input Impedance (DC)	1 MΩ	
Input Capacitance	10 pF	
Intrinsic Noise ⁽²⁾ (standard deviation in % of the span)	< 0.02%	
CMRR (Common mode rejection range)	> -120 dB	
Crosstalk	> -120 dB	
Channel Isolation	CH to CH and CH to GND, > 100 MΩ at 2000 VDC	
Safety	CAT III 1500 VDC, CAT IV 1000 V	
Bandwidth and Filters		
Bandwidth (-3 dB)	Ranges ≤ ± 2.5 V	30 kHz
	Ranges ≥ ± 50 V	100 kHz
Analog Filter	3rd order(-60 dB/dec)	100 Hz, 1 kHz, 10 kHz
Digital Filter	IIR 4th order (-80 dB/dec)	0.01 Hz to 10 kHz
	Type	Low pass, high pass, band pass, band stop
	Filter response	Butterworth, Bessel, Chebyshev, Inverse Chebyshev, elliptic, Papoulis, Gaussian

Data Acquisition		
ADC	16 bit - SAR	
Sampling Interval	1 µs (1 MSa/s) each channel	
Time and Counting		
Threshold	Set by user, auto	
Duty Cycle	10% minimum - minimum pulse width 20 µs	
Counter	48 bits	
Frequency	0.1 Hz to 50 kHz	
	Accuracy: 0.01% from 0.1 Hz to 10 Hz 0.05% of the value from 10 Hz to 50 kHz	
PWM	Absolute error: 0.1% - 0.1 Hz to 1 kHz 0.5% ≥ 1 kHz to 5 kHz	
True RMS		
Compute Period	Compute on the 1 Ms/s data flow Each period until 100 Hz 10 ms between 100 Hz and 10 kHz	
Accuracy (on a Sine wave for range ≥ 10 V)	10 Hz to 2 kHz	± 0.1% of full range
	2 kHz to 10 kHz	± 0.3% of full range
Other		
Current	Through shunt or clamp	
Sensor	0 to 10 V, 4 to 20 mA (with external shunt), duty cycle or frequency sensor, and other user defined settings	
Calculations	Derivative, integral, min - max - avg - pk to pk on Δt	

(1) Direct measure, full bandwidth, value taken on DMM display at 10 (50 Hz) / 12 (60 Hz) NLPC (200 ms)

(2) Measure ± short circuit terminate to 50 Ω on chassis during 1 sec at the fastest acquisition speed and full bandwidth

(3) CH to Earth GND withstand voltage 6.6 kV AC for 5 seconds

Chapitre 11**Servicing****11.1 | For users not based in America****11.1.1 Warranty**

Your instrument is guaranteed for three years (36 months) parts and labor against any manufacturing defect or operating hazard. This warranty begins on the date of delivery and ends 1095 calendar days later. If the device is covered by a warranty contract, the latter supersedes or replaces the warranty conditions listed above. The warranty conditions applicable by SEFRAM are available on the website www.sefram.com, the general warranty conditions prevail over the present one which is a summary. This warranty does not cover defects resulting from abnormal use, handling errors or storage conditions outside the defined range.

In the event of a warranty claim, the user must return the device concerned to our factory at his or her own expense following the return procedure indicated on our website : <https://www.sefram.com/services.html>

SEFRAM Instruments SAS

Service Après-vente

32, Rue Edouard MARTEL

BP 55

42009 SAINT-ETIENNE CEDEX 2

For customers in North America, please return the device to the address mentioned below and follow the instructions given on our website <https://www.bkprecision.com/support>

B&K Precision Corp.

: 22820 Savi Ranch Parkway

Yorba Linda, CA 92887

bkprecision.com

714-921-9095

The device must be accompanied by a detailed description of the fault, and must be returned with all standard accessories (cords, plugs, etc.). Consumables (batteries, etc.) and optional accessories (case, bag, etc.) are guaranteed for 3 months against manufacturing defects. Components such as LCD screens and touch panels are only guaranteed for normal use. Wear and tear, accidental breakage due to impact or abnormal use are not guaranteed*. *See the conditions for acceptance of a touch screen below. Factory-installed options are guaranteed for the same duration as the device. The ssd hard disk is guaranteed for 2000 complete write cycles. The battery (if the battery option is present) is guaranteed for 200 charge/discharge cycles. The remaining warranty period in the event of product replacement or repair is :

- Time remaining to cover warranty period
- If the device warranty < 90 days, the replaced part is guaranteed for 90 days.

The warranty period for after-sales service outside the appliance warranty period is 3 months. All spare parts become the property of the user, and replaced parts become the property of SEFRAM. In the event of insurance coverage, the product becomes the property of the insurance company at its exclusive request. Otherwise it remains the property of the user. The warranty applies only to equipment manufactured and supplied by SEFRAM. Any intervention or modification carried out by the user or by a third party without prior authorization from the company will invalidate the warranty. The user is responsible for returning the device to our premises. He must therefore ensure that the packaging provides adequate protection during transport. We recommend using the original packaging. The customer is responsible for taking out the necessary transport insurance. SEFRAM reserves the right to refuse poorly-packaged products, and not to offer repairs if the breakage is due to transport. Particular case of the battery : if a Li-ion battery is fitted to this device. It must not be transported outside the unit. Under no circumstances should it be replaced by the user. It must be replaced at the factory, so that the charging system and protective devices can be checked. This equipment must be transported in accordance with international guidelines for the carriage of equipment containing hazardous materials.

11.1.2 After-sales contact

Help with operation and malfunctions :

In the event of a malfunction, please check the software version of your device first, or contact our technical support if you have problems using it.

+33 (0)4 77 59 01 01

Or send an e-mail to :

support@sefram.com or support@bkprecision.com (For North America customers)

11.1.3 In case of breakdown

In the event of a breakdown, please return your equipment together with the RMA document previously registered on our website to <https://www.sefram.com/services.html> or <https://www.bkprecision.com/support>

You can call our customer service department at :

+33 (0)4 77 59 36 91 or 800-462-9832 (US & CAN toll free)

Or contact :

services@sefram.com or <https://www.bkprecision.com/support/request/technician>

11.1.4 Packaging

The packaging for this product is entirely recyclable. Thanks to its design, it enables your instrument to be transported in the best possible conditions. We draw your attention to the fact that the original packaging must be over-packed, if it is to be used for transport by air, road or post. We recommend keeping the original packaging for all transport.

11.1.5 LCD Display Defects

Your SEFRAM device is equipped with an active matrix color LCD display. This screen is sourced from reputable manufacturers. Under current technical manufacturing conditions, these manufacturers are unable to guarantee 100% correct operation of the pixels in the display area. They specify a number of defective pixels on the screen surface. SEFRAM's quality department has made installation of your instrument's display conditional on compliance with the manufacturers' acceptance conditions.

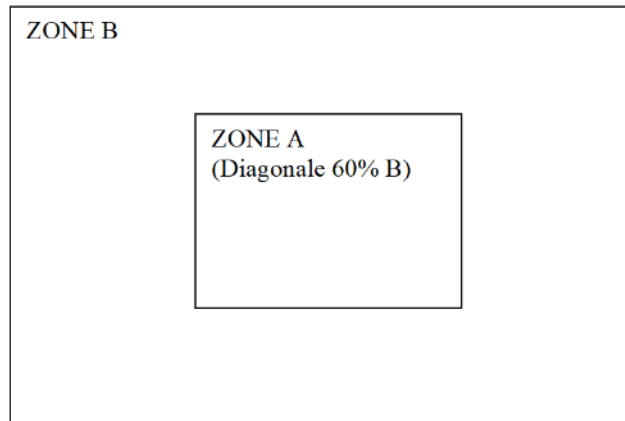

FIGURE 11.1 : Display areas

Acceptance criteria :

- Zone A (central zone) : fewer than 5 defective pixels in total and fewer than 3 contiguous pixels.
- Zone B (total screen area) : less than 9 defective pixels over the entire screen area, with Zone A conditions met.

Defective pixels are defined as a point on the screen that remains unlit or lights up in a color other than the one expected. The contractual warranty only applies to the device in your possession if the above criteria are not met. This applies both at the time of delivery and during the warranty period.

11.2 | For users based in America

11.2.1 Warranty

Please go to the support and service section on our website at bkprecision.com to obtain an RMA #. Return the product in the original packaging with proof of purchase to the address below. Clearly state on the RMA the performance problem and return any leads, probes, connectors and accessories that you are using with the device. Non-Warranty Service : Please go to the support and service section on our website at bkprecision.com to obtain an RMA #. Return the product in the original packaging to the address below. Clearly state on the RMA the performance problem and return any leads, probes, connectors and accessories that you are using with the device. Customers not on an open account must include payment in the form of a money order or credit card. For the most current repair charges please refer to the service and support section on our website. Return all merchandise to B&K Precision Corp. with prepaid shipping. The flat-rate repair charge for Non-Warranty Service does not include return shipping. Return shipping to locations in North America is included for Warranty Service. For overnight shipments and non-North American shipping fees please contact B&K Precision Corp. Include with the returned instrument your complete return shipping address, contact name, phone number and description of problem.

B&K Precision Corp.

: 22820 Savi Ranch Parkway

Yorba Linda, CA 92887

bkprecision.com

714-921-9095

The device must be accompanied by a detailed description of the fault, and must be returned with all standard accessories (cords, plugs, etc.). Consumables (batteries, etc.) and optional accessories (case, bag, etc.) are guaranteed for 3 months against manufacturing defects. Components such as LCD screens and touch panels are only guaranteed for normal use. Wear and tear, accidental breakage due to impact or abnormal use are not guaranteed*. *See the conditions for acceptance of a touch screen below. Factory-installed options are guaranteed for the same duration as the device. The ssd hard disk is guaranteed for 2000 complete write cycles. The battery (if the battery option is present) is guaranteed for 200 charge/discharge cycles. The remaining warranty period in the event of product replacement or repair is :

- Time remaining to cover warranty period
- If the device warranty < 90 days, the replaced part is guaranteed for 90 days.

The warranty period for after-sales service outside the appliance warranty period is 3 months. All spare parts become the property of the user, and replaced parts become the property of B&K Precision. In the event of insurance coverage, the product becomes the property of the insurance company at its exclusive request. Otherwise it remains the property of the user. The warranty applies only to equipment manufactured and supplied by B&K Precision. Any intervention or modification carried out by the user or by a third party without prior authorization from the company will invalidate the warranty. The user is responsible for returning the device to our premises. He must therefore ensure that the packaging provides adequate protection during transport. We recommend using the original packaging. The customer is responsible for taking out the necessary transport insurance. B&K Precision reserves the right to refuse poorly-packaged products, and not to offer repairs if the breakage is due to transport. Particular case of the battery : if a Li-ion battery is fitted to this device. It must not be transported outside the unit. Under no circumstances should it be replaced by the user. It must be replaced at the factory, so that the charging system and protective devices can be checked. This equipment must be transported in accordance with international guidelines for the carriage of equipment containing hazardous materials.

11.2.2 Packaging

The packaging for this product is entirely recyclable. Thanks to its design, it enables your instrument to be transported in the best possible conditions. We draw your attention to the fact that the original packaging must be over-packed, if it is to be used for transport by air, road or post. We recommend keeping the original packaging for all transport.

11.2.3 After-sales contact

Help with operation and malfunctions or breakdown :

In the event of a malfunction, please check the software version of your device first, or contact our technical support if you have problems using it.

support@bkprecision.com

11.2.4 Elements of tactile acceptance

Your SEFRAM device is equipped with an active matrix color LCD display. This screen is sourced from reputable manufacturers. Under current technical manufacturing conditions, these manufacturers are unable to guarantee 100% correct operation of the pixels in the display area. They specify a number of defective pixels on the screen surface. SEFRAM's quality department has made installation of your instrument's display conditional on compliance with the manufacturers' acceptance conditions.

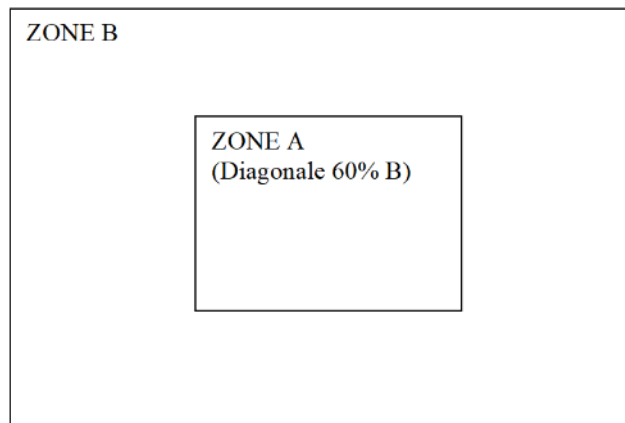

FIGURE 11.2 : Display areas

Acceptance criteria :

- Zone A (central zone) : fewer than 5 defective pixels in total and fewer than 3 contiguous pixels.
- Zone B (total screen area) : less than 9 defective pixels over the entire screen area, with Zone A conditions met.

Defective pixels are defined as a point on the screen that remains unlit or lights up in a color other than the one expected. The contractual warranty only applies to the device in your possession if the above criteria are not met. This applies both at the time of delivery and during the warranty period.

Chapter 12

Annexes

12.1 | Revisions

Version and date	Firmware version associated	Modified chapters	Modification type
4.1 - 03/2026	4.1.x	All	Document creation

12.2 | SCPI Protocol

12.2.1 Physical link

SCPI is based over the LAN interface that can be connected via a commercial RJ-45 cable to a network with TCP/IP protocol. The TCP port used is **23** (Telnet port) or **5025** (both are enabled on the device).

12.2.2 Command syntax

SCPI commands to an instrument may either perform:

- Command operation (e.g. switching a power supply on)
- Query operation (e.g. reading a voltage). Queries are issued to an instrument by appending a question-mark to the end of a command.

Use a semicolon (;) to separate multiple commands e.g. *IDN? ; VALID?

Command abbreviating

The command syntax shows some characters in a mixture of upper and lower case. Abbreviating the command to only sending the upper case **has the same meaning as sending the upper and lower case command.**

For example, the command "DATE" could also alternatively be abbreviated as "DAT"

Arguments

Some commands require an additional argument. Arguments are given after the command, and are separated by a space. For example, the command to set the trigger mode of an instrument to "normal" may be given as "TRIGger:MODE Normal". Here, the word "Normal" is used as the argument to the "TRIGger:MODE" command.

There are several types of data items:

- Alphanumeric data: 1 to 12-character words that can be alphabetical (upper or lower case) digital or the "-" character (95d). A word always starts with an alphabetical character. For example, for a non-digital parameter: S1M.
- Decimal digital data: Made of a significand and, possibly, an exponent, and displayed as a chain of ASCII-coded characters starting with a digit or a sign (+ or -).
- Text: Any chain of characters under 7-bit ASCII code, between quotation marks (") or apostrophes ('). For example: "Channel 1"

Examples

```
>> Send : *IDN?
<< Rcv : DAS1800 V0.0.4 (N0012)

>> Send : VALID?
<< Rcv : Ch_B1 ;Ch_B2 ;Ch_B3 ;

>> Send : *OPT?
<< Rcv : No options

>> Send : DAT?
<< Rcv : 05,11,2022

>> Send : :DAT?
<< Rcv : 05,11,2022

>> Send : :DATE?
<< Rcv : 05,11,2022

>> Send : :RDC?
<< Rcv : Ch_B1 Direct 1.12572;Ch_B2 Direct -0.756034;Ch_B3 Direct -1.78915;

>> Send : HOUrs?
<< Rcv : 09,27,37

>> Send : FILE:NAME?
<< Rcv : RecordFile
```

12.2.3 Command list

Request list

HEADER	DESCRIPTION	RESPONSE	EXAMPLE
*IDN?	Identification request	SEFRAM, Product Name, Serial Number, VersionMajor.VersionMinor	SEFRAM 8460 Version 4.7.2 (N:00010)
*OPT?	Identification of options	Number of acquisition modules	
*OPC?	Operation complete	1	
:DATE?	Return the current date	Day,Month,Year	30,12,2022
:HOURs?	Return the current time	Hour,Minutes,Seconds	09,53,37
RDC?	Read all measurement values	Measurement name, type and values separated by comma	Ch_B1 Direct 0.1514, Ch_B2 Direct 8.9716
REC?	Read recording state	Idle Waiting for trigger Recording	Waiting for trigger
VALID?	Read list of all the enabled measurements	Measurement name and type separated by comma	Ch_B1 Direct, Ch_B2 Direct
:FILE:NAME?	Read record file name	File name string	MyFileName
SYST:ERR?	Pop off the last error from the SCPI error queue	Error string	-109, Missing parameter

Table 12.1: SCPI request description

Command list

HEADER	DESCRIPTION	PARAMETERS	EXAMPLE
*REM	Start remote control		*REM
*LOC	Stop remote control		*LOC
:MEMSpeed	Set recording frequency	Frequency (Hz)	:MEMSpeed 10000
REC	Start or stop recording on the device	ON OFF TRIG (useful if the device is in state «Waiting for trigger» to force starting)	REC ON
:START:MANual	Set the start recording condition as «Manual»		:START:MANual
:STOP:MANual	Set the stop recording condition as «Manual»		:STOP:MANual
:START:TRIG	Set the start recording condition as «Signal»	Mode: or, and Optional: File index if multiple files	:START:TRIG or
:STOP:TRIG	Set the stop recording condition as «Signal»	Mode: or, and Optional: File index if multiple file	
:TRIG:REset	Reset signal trig condition	Type of trig : Start, Stop Optional: File index if multiple files	TRIG:REset Start TRIG:REset Stop 2
:TRIG:ADD	Add a condition for signal trig	Type of trig : Start, Stop File index if multiple file Channel alias Measurement type Trigger type: Level_greater Level_lower Edge_rising Edge_falling Edge_both Window_in Window_out Threshold1 Threshold2 Filter value	:TRIG:ADD start, 1, A2, Direct, Level_lower, 1.33, 2, 0.33

Table 12.3: SCPI command description

HEADER	DESCRIPTION	PARAMETERS	EXAMPLE
:SCREEN	Change current screen	Tab: REplay, SETUP, SCOpe Optional: Scope name (F(t), DMM etc.)	:SCREEN REPLAY :SCREEN SCOPE DMM
:FILE:NAME	Set record file name	File name Optional : File index if multiple files	:FILE:NAM myFileName :FILE:NAME myFileName 2
:REB	Reboot the product		
:VIEWer	Open a record file	File name	:VIEWer myFileName
:STore	Save the current acquisition configuration (*.acq)	Setting file path	:STore myFileName
:STORESYStem	Save the current system configuration (*.sys)	Setting file path	:STORESYStem myFileName
:RECALL	Load a configuration file (*.acq)	Setting file path	:RECALL myFileName
:SYST:ERR	Clear the SCPI error queue		:SYST:ERR
:SCReenshot	Make a screenshot and save it into the working directory in bitmap format (*.bmp)	Optional: File name If undefined, the name is auto-generated	:SCR :SCR myscreenshot

Table 12.5: SCPI command description

HEADER	DESCRIPTION	PARAMETERS	EXAMPLE
:CHANnel:RANGE	Update the range of the specified channel	Channel alias Min value of the range Maximum value of the range (Requirement: MIN < MAX)	:CHAN:RANGE A1,-15,10 :CHAN:RANGE B1,-5.5,5.5
:CHANnel:MEASurement	Enable the specified measurement on the specified channel. If no measurement is specified the direct measurement will be activated.	Channel alias Measurement to enable [Counter, Frequency, RMS, Direct, PWM, Derivate, Integrate, Min, Max, Mean, PeakToPeak] Enable or disable ON, OFF	:CHAN:MEAS B1,ON :CHAN:MEAS B1, RMS,OFF
:CHANnel:SENSor	Configure the specified sensor on a channel. The sensor must be available in the sensor library. For a voltage without any sensor use : No_sensor_voltage_measurement. For resistor measure without sensor use : No_sensor_resistor_measurement /\ The sensor name is case sensitive	Channel alias Sensor name	:CHAN:SENS A1, SP201 :CHAN:SENS A2, No_sensor_voltage_measurement :CHAN:SENS A3, Thermocouple_K
:CHANnel:WIRing	Configure the given wiring on a channel. The wiring must be consistent with the module and the sensor. Values are «2_wire_resistor_measure» «3_wire_resistor_measure» «4_wire_resistor_measure»	Type of wiring	:CHANnel:WIRING C1, 3_wire_resistor_measure

Table 12.7: SCPI command description

Example

Bellow an example of Python implementation

Listing 12.1: SCPI python implemntation exemple

```
import time
import telnetlib

TIMEOUT = 0.5  # Timeout on frame receive
PORT = 23

##### Low level functions #####

# Remove end of line chars to print
def extractCmd(cmd):
    cmd = cmd.replace("\n", "")
    cmd = cmd.replace("\r", "")
    return cmd

# Send a frame and wait for response
def sendFrame(tn, cmd):
    cmd = cmd + "\n"
    print(">>Send:_" + extractCmd(cmd))
    tn.write(cmd.encode('ascii'))
    res = tn.read_until(b'\n', TIMEOUT).decode('ascii')
    if len(res) == 0:
        print("Timeout")
        time.sleep(1)
    else:
        print("<<Rcv:_" + res)
    return res

class scpi(object):

    def __init__(self, ip):
        self.tn = telnetlib.Telnet(ip, PORT, TIMEOUT)

    def runCmd(self, frame):
        return sendFrame(self.tn, frame)

    def __del__(self):
        self.tn.close()

scpiInst = scpi("192.168.0.110")
scpiInst.runCmd('*REM')
scpiInst.runCmd('*IDN?')
scpiInst.runCmd('VALID?')
scpiInst.runCmd('*LOC')
```

12.3 | EU Declaration of conformity

EU DECLARATION OF CONFORMITY*DECLARATION DE CONFORMITE UE*

Manufacturer's Name: SEFRAM INSTRUMENTS SAS
Nom du fabricant :

Manufacturer's Address: 32, rue Edouard MARTEL
Adresse du fabricant : 42009 SAINT-ETIENNE Cedex 2 (FRANCE)

declares under sole responsibility that the below mentioned product(s)
déclare sous sa seule responsabilité que le(s) produit(s) mentionné(s) ci-dessous

Product Name:
Nom du produit : Data acquisition systems

Model Number(s): **DAS 1820**
Numéro(s) de modèle :

comply with the essential requirements of the following applicable European Directives:
sont conformes aux exigences essentielles des directives européennes applicables suivantes :

Low Voltage Directive (LVD) 2014/35/EU
Radio equipment - Directive 2014/53/EU
Restrictions on Hazardous Substances (RoHS) Directive 2011/65/EU
Batteries and waste batteries - Directive 2023/1542/EU

and are in conformity with the following harmonized standards:
et sont conformes aux normes harmonisées suivantes :

LVD	EN 61010-1:2010/A1:2019
RED	EN 61326-1 : 2021 ETSI 301 489-1 (V2.2.3) ETSI 301 489-19 (V2.1.1) ETSI EN 303 413 V1.2.1 (2021-04)
RoHS	EN 63000:2018
BATTERY	EN 62133-1 : 2017

Compliance was demonstrated in listed laboratory and record in a test report
La conformité a été démontrée dans un laboratoire répertorié et enregistrée dans un rapport d'essai.

SAINT-ETIENNE the:
09/02/2026

Name/Position:
CLERJON / Quality Manager

